



Buckeye

HARDWARE

DISTRIBUTING, LTD.

2024 Retail
Catalog

Amerock

TABLE OF CONTENTS

▪ Amerock	3
▪ Belwith Keeler	81
▪ Elements	131
▪ Euro Hinges	186
▪ H Select	47
▪ Jeffrey Alexander	91
▪ Wood Handles	73
▪ Wood Knobs	71

INFORMATION

WAREHOUSE LOCATION

1465 Twp Rod 178
Baltic, OH 43804

WAREHOUSE HOURS

Monday - Friday 6:30 AM - 3:00 PM

FAX ORDER LINE

330-897-0022

EMAIL

BuckeyeOrders@ibifax.com

PHONE

330-897-0017

INDIANA SALES

Ervin Miller 260-593-0225

Weekly delivery to Northern Indiana

Under \$25.00 will have a

\$10.00 delivery charge

RETURNS

All returns will be subject

to a 20% restock charge

Must Include Invoice Number

SHIPPING CHARGES

\$12.00 for orders under \$100

\$15.00 for \$100 - \$199

\$18.00 for \$200 - \$299

\$20.00 for \$300 - \$399

\$25.00 for \$400 - \$599

\$30.00 for \$600 - \$999

\$50.00 for \$1000 - \$1999

Free Shipping over \$2000

PRICES SUBJECT TO CHANGE WITHOUT NOTICE

Catalog proudly designed and printed by:

 **SCHLABACH PRINTERS**
schlabachprinters.com

Amerock®



FULL LINE MASTER DISTRIBUTOR OF AMEROCK
THIS PAGE FOR COLOR REFERENCE ONLY

SILVER TONES



26, CH
POLISHED CHROME



PN
POLISHED NICKEL



G10, SN
SATIN NICKEL (MATTE)



SC
SILVER CHAMPAGNE



G9
STERLING NICKEL



S
SILVER



G10
SATIN NICKEL



14
NICKEL



SS
STAINLESS STEEL



AA
ANODIZED ALUMINUM



26D, SCH
BRUSHED CHROME



BBN
BLACK BRUSHED NICKEL



BCR
BLACK CHROME



AS
ANTIQUÉ SILVER



AP
AGED PEWTER



AN
ANTIQUÉ NICKEL



WN
WEATHERED NICKEL



WNC
WEATHERED NICKEL COPPER

GOLD TONES



CZ
CHAMPAGNE BRONZE



BBZ
BRUSHED BRONZE OR GOLDEN CHAMPAGNE



3, PB
POLISHED BRASS



GB
GILDED BRONZE



AE
ANTIQUÉ ENGLISH



EB
ELEGANT BRASS



O77, BB
BURNISHED BRASS



AB, ABS
ANTIQUÉ BRASS



DBS
DISTRESSED BRASS



R1
REGENCY BRASS



R2
WEATHERED BRASS



R3
RUSTIC BRASS



THIS PAGE FOR COLOR REFERENCE ONLY

BOLD TONES



AC
ANTIQUE COPPER



BC
BRUSHED COPPER



WC
WEATHERED
COPPER



RBZ
RUSTIC BRONZE



CBZ
CARMEL BRONZE



ART
ANTIQUE RUST



VS
VIRIDIAN SLATE



RB
ROMAN BRONZE



VB
VENETIAN
BRONZE



ORB
OIL-RUBBED
BRONZE



DOB
DARK OILED
BRONZE

BLACK TONES



WI, WID
WROUGHT IRON
OR WROUGHT
IRON DARK



PWT
PEWTER



GM
GUNMETAL



GPH
GRAPHITE



BN, BNB
BLACK NICKEL



BBR
BLACK BRONZE



FB
FLAT BLACK



CB
COLONIAL BLACK



MB
MATTE BLACK

MISCELLANEOUS TONES



30, W, 54, GW
WHITE



MW
MARBLE WHITE

EVERYDAY HERITAGE



1910-G10
1 1/4" DIA
1 1/8" PROJ



G10



53018-G10
1 3/8" L
1 1/2" PROJ



ORB G10 26



69151-G10
1 1/2" DIA
3/4" PROJ



G10



3413-26
1 1/2" DIA
5/8" PROJ



26



888-AE
1 3/8" DIA
5/8" PROJ



AE



53001-ORB
1 1/4" DIA
7/8" PROJ



ORB



53011-G10
1 1/4" DIA
1 1/8" PROJ



FB ORB G10



53015-G10
1 1/4" DIA
1" PROJ



FB ORB G10



173-ORB
3" C/C | 4 5/8" L



ORB G10



29113-G10
1 1/4" DIA
3/4" PROJ



ORB G10



29115-G10
1 1/2" DIA
1 1/8" PROJ



G10



53006-ORB
3" C/C | 3 3/8" L



ORB



3401-CB
3 1/4" C/C | 5 1/16" L



CB



3403-CB
1 1/4" DIA
3/4" PROJ



CB



29111-G10
128MM C/C | 6" L



G10



52996-G10
96MM C/C | 4 13/16" L



G10



69153-G10
3" C/C | 4" L



G10



3416-26
3" C/C | 4" L



26



53009-G10
3" C/C | 3 3/8" L



G10



76312-G10
4" C/C | 4 1/4" L



G10



867-CS26D
3 1/2" C/C | 3 13/16" L



CS26D CSG10



76313-26
6" C/C | 4 1/4" L



26

AVAILABLE FINISHES



36758-CZ
1 1/4" DIA | 1" PROJ



36762-CZ
76MM C/C | 4 7/8" L



36763-CZ
96MM C/C | 7 7/16" L



36764-CZ
76MM C/C | 3 3/4" L



36759-CZ
96MM C/C | 4 9/16" L



36760-CZ
128MM C/C | 5 13/16" L



36761-CZ
192MM C/C | 8 5/16" L



54030-CZ
12" C/C | 13" L



54030-CZ
18" C/C | 19" L



ASHBY

AVAILABLE FINISHES

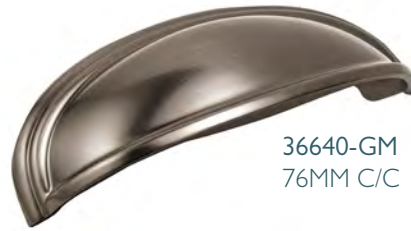

36640-GM
76MM C/C | 5 1/8" L

BAR PULLS

AVAILABLE FINISHES



19010-SS
3" C/C | 5 3/8" L



19011-SS
96MM C/C | 6 1/8" L



19541-SS
128MM C/C | 7 3/8" L



19012-SS
192MM C/C | 9 15/16" L



19013-SS
256MM C/C | 13 1/4" L

BAR PULLS

19009-ORB
2" L | 1 3/8" PROJ

BBR ORB CZ BBZ CSG9 SS PN 26

40515-ORB
3" C/C | 5 3/8" L

BBR ORB CZ BBZ PN 26

40516-ORB
96MM C/C | 6 1/8" L

BBR ORB CZ BBZ PN 26

40517-ORB
128MM C/C | 7 3/8" L

BBR ORB CZ BBZ PN 26

40518-ORB
192MM C/C | 9 7/8" L

BBR ORB CZ BBZ PN 26

40519-ORB
256MM C/C | 13 1/4" L

BBR ORB CZ BBZ PN 26

54008-ORB
12" C/C | 14 5/8" L

BBR ORB BBZ CSG9 SS PN

19014-ORB
320MM C/C | 15 3/4" L

BBR ORB CZ BBZ CSG9 SS PN 26

19015-ORB
416MM C/C | 19 1/2" L

ORB CSG9 SS

54025-ORB
18" C/C | 20 5/8" L

BBR ORB BBZ SS PN

19016-ORB
480MM C/C | 22" L

BBR ORB CZ BBZ CSG9 SS PN 26

19017-ORB
544MM C/C | 24 9/16" L

ORB CSG9 SS

19018-ORB
640MM C/C | 28 3/8" L

ORB CSG9 SS

19019-ORB
768MM C/C | 33 3/8" L

ORB CSG9 SS



BLACKROCK

AVAILABLE FINISHES



55274-BBZ
1 13/16" L | 3/4" PROJ



55270-BBZ
1 5/16" DIA | 1" PROJ



55275-BBZ
3" C/C | 3 3/4" L



55272-BBZ
1 5/8" DIA | 1 1/4" PROJ



55276-BBZ
96MM C/C | 4 5/8" L



55271-BBZ
1 3/16" L | 1 1/16" PROJ



55277-BBZ
128MM C/C | 6" L



55278-BBZ
160MM C/C | 7 1/4" L



55273-BBZ
1 1/2" L | 1 3/8" PROJ



55282-BBZ
203MM C/C | 8 15/16" L



55283-BBZ
256MM C/C | 11" L



55284-BBZ
320MM C/C | 13 9/16" L



55280-BBZ
12" C/C | 13 3/8" L



55281-BBZ
18" C/C | 19 3/8" L

AVAILABLE FINISHES



BRONX



36557-GM
3" OR 3 3/4" C/C | 4 11/16" L



36556-GM
2 5/8" C/C | 5/8" L



36558-GM
5 1/16" C/C | 5 15/16" L



36559-GM
6 5/16" C/C | 7 3/16" L



36562-GM
8" C/C | 8 7/8" L



36560-GM
10 1/16" C/C | 11" L



36561-GM
12 5/8" C/C | 13 1/2" L



54070-GM
12" C/C | 13" L



54071-GM
18" C/C | 19" L



54072-GM
24" C/C | 25" L



CALATHEA

AVAILABLE FINISHES



BCR G10

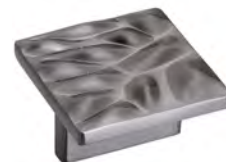

10132-BCR
1 1/4" L | 1 1/8" PROJ

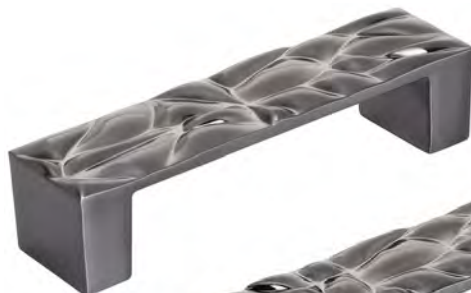

100396-BCR
3 3/4" C/C | 4 7/16" L



1003128-BCR
5 1/16" C/C | 5 11/16" L



1003160-BCR
6 5/16" C/C | 7" L

CALIBER

AVAILABLE FINISHES



FB ORB CZ G10 26



36872-ORB
1 1/4" DIA | 1 3/16" PROJ



37365-ORB
76MM C/C | 5 1/8" L



36873-ORB
96MM C/C | 5 7/8" L



36874-ORB
128MM C/C | 7 1/8" L



36875-ORB
160MM C/C | 8 7/16" L



36876-ORB
192MM C/C | 9 11/16" L



36877-ORB
256MM C/C | 12 3/16" L

CANDLER

AVAILABLE FINISHES



29349-BBZ
3" C/C | 4 3/8" L



29340-BBZ
1 1/4" L | 1 1/8" PROJ



29355-BBZ
96MM C/C | 5 1/8" L



29368-BBZ
1 1/2" L | 1 1/4" PROJ



29363-BBZ
128MM C/C | 6 1/2" L



29364-BBZ
160MM C/C | 8" L



29366-BBZ
12" C/C | 14 5/8" L



29367-BBZ
18" C/C | 20 3/4" L



AVAILABLE FINISHES



CARRIONE



36648-MW/BBZ
3 3/4" C/C | 6 5/16" L



36647-MW/BBZ
2 1/2" L | 1 9/16" PROJ



36649-MW/BBZ
5 1/16" C/C | 7 1/2" L



36650-MW/BBZ
6 5/16" C/C | 8 3/4" L



CONCENTRIC

AVAILABLE FINISHES

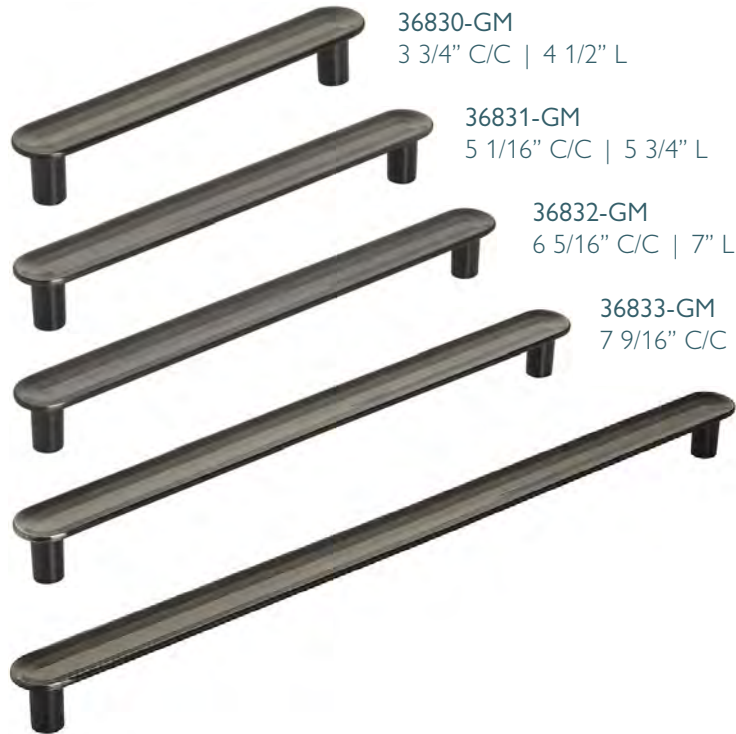

36830-GM
3 3/4" C/C | 4 1/2" L

36831-GM
5 1/16" C/C | 5 3/4" L

36832-GM
6 5/16" C/C | 7" L

36833-GM
7 9/16" C/C | 8 1/4" L

36834-GM
10 1/16" C/C | 10 3/4" L



36810-GM
1 9/16" DIA | 1 9/16" L



36812-PN
3 3/4" CC | 4 3/16" L

36813-PN
5 1/16" CC | 5 7/16" L

36814-PN
6 5/16" CC | 6 11/16" L

36815-PN
7 9/16" CC | 7 15/16" L

36816-PN
10 1/16" CC | 10 7/16" L



36811-PN
1 1/4" CC | 1 11/16" L



CRAWFORD

AVAILABLE FINISHES



36593-BBZ
3 3/4" C/C | 4 11/16" L

36594-BBZ
5 1/16" C/C | 6 1/16" L

36595-BBZ
6 5/16" C/C | 7 3/8" L



36613-BBZ
1 3/8" DIA | 1 3/16" PROJ



CUP PULLS

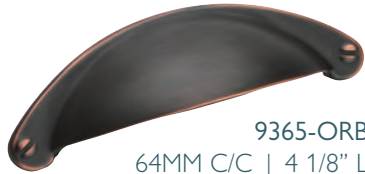

9365-ORB
64MM C/C | 4 1/8" L



53019-G10
2 1/2" C/C | 3 1/8" L



53010-G10
3" C/C | 3 3/8" L

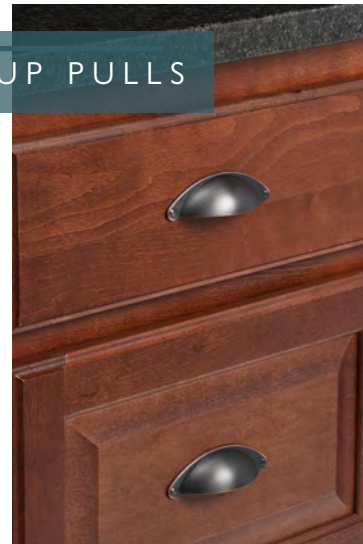

EDONA

AVAILABLE FINISHES



53005-CZ
1 1/4" DIA | 1 1/8" PROJ



ERA

AVAILABLE FINISHES



36907-G10
1 1/4" DIA | 1 1/8" PROJ



CYPRUS

AVAILABLE FINISHES



26201-BBZ
3" C/C | 5 1/4" L

26203-BBZ
96MM C/C | 6 9/16" L

9362-BBZ
128MM C/C | 7 3/16" L

26204-BBZ
160MM C/C | 9 1/8" L

26206-BBZ
12" C/C | 16" L
NOT AVAILABLE IN: CZ, 26

26207-BBZ
18" C/C | 22" L
NOT AVAILABLE IN: CZ, 26

DAVENPORT

AVAILABLE FINISHES



36600-ORB
3" C/C | 4 1/2" L

36605-ORB
3 3/4" C/C | 5 5/16" L

36606-ORB
1 1/2" L | 1 3/8" PROJ
5 1/16" C/C | 6 9/16" L

36607-ORB
6 5/16" C/C | 7 13/16" L

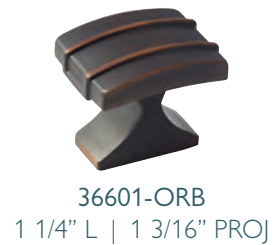

36601-ORB
1 1/4" L | 1 3/16" PROJ



36602-ORB
1 1/2" L | 1 3/8" PROJ



DESTINE

AVAILABLE FINISHES



- 

37370-G10
76MM C/C | 4 1/8" L
- 

36858-G10
96MM C/C | 4 15/16" L
- 

36859-G10
128MM C/C | 6 3/16" L
- 

36860-G10
160MM C/C | 7 7/16" L
- 

36861-G10
224MM C/C | 9 15/16" L
- 

54035-GM
12" C/C | 14 15/16" L
- 

5403-GM
18" C/C | 20 15/16" L





36857-G10
1 3/8" L | 1" PROJ

AVAILABLE FINISHES

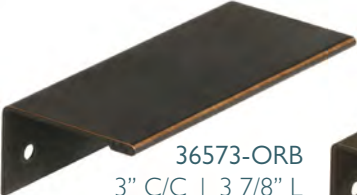

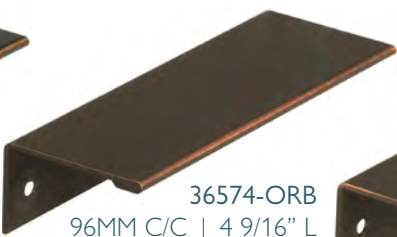
- 

36573-ORB
3" C/C | 3 7/8" L
- 

36574-ORB
96MM C/C | 4 9/16" L
- 

36575-ORB
128MM C/C | 5 13/16" L

EDGE PULLS



ESQUIRE

AVAILABLE FINISHES



- 

36556-G10ORB
2 5/8" L | 1 1/2" PROJ
- 

36557-G10ORB
3" C/C | 4 11/16" L
- 

36558-G10ORB
128MM C/C | 5 15/16" L
- 

36559-G10ORB
160MM C/C | 7 3/16" L
- 

36562-G10ORB
203MM C/C | 8 7/8" L
- 

36560-G10ORB
256 MM C/C | 11" L
- 

36561-G10ORB
320MM C/C | 13 1/2" L
- 

54040-G10ORB
12" C/C | 13" L
- 

54041-G10ORB
18" C/C | 19" L
- 

54042-G10ORB
24" C/C | 25" L

ESSENTIAL'Z STAINLESS STEEL

AVAILABLE FINISH



19001-SS
3" C/C | 3 5/8" L



19002-SS
96MM C/C | 4 9/16" L



19003-SS
128MM C/C | 5 15/16" L



19004-SS
160MM C/C | 7 3/8" L



19005-SS
192MM C/C | 8 7/8" L



19008-SS
1 1/4" DIA
1 1/8" PROJ



26200-SS
32MM DIA
1" PROJ

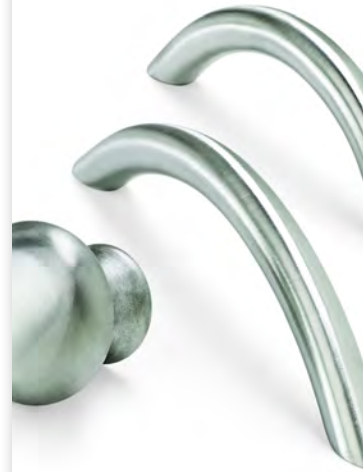

AVAILABLE FINISHES



37375-CZ
76MM C/C | 4 1/2" L



36881-CZ
96MM C/C | 5 1/4" L



36882-CZ
128MM C/C | 6" L



36883-CZ
160MM C/C | 7 1/4" L



36884-CZ
224MM C/C | 9 13/16" L



36880-CZ
1 1/2" DIA | 1 3/16" PROJ

EXCEED



EVERETT

AVAILABLE FINISHES



37103-G10
76MM C/C | 4 9/16" L



37104-G10
96MM C/C | 5 5/16" L



37105-G10
128MM C/C | 6 3/4" L



37106-G10
160MM C/C | 8 1/16" L



37107-G10
192MM C/C | 9 7/16" L



37108-G10
224MM C/C | 11" L



37109-G10
256MM C/C | 12 1/4" L



37110-G10
305MM C/C | 14 11/16" L



37111-G10
457MM C/C | 20 11/16" L



37100-G10
1 3/4" L | 1 1/4" PROJ



37101-G10
1 1/4" DIA | 1 3/16" PROJ



37102-G10
1 5/16" DIA | 1 1/4" PROJ



EXTENSITY

AVAILABLE FINISHES



29379-G10
3" C/C | 4 1/8" L



29385-G10
96MM C/C | 5" L



29393-G10
128MM C/C | 6 1/4" L



29394-G10
160MM C/C | 7 1/2" L



29370-G10
1 3/16" L | 1 1/16" PROJ



AVAILABLE FINISHES



37380-G10
76MM C/C | 3 5/8" L



36781-G10
96MM C/C | 4 5/16" L



36782-G10
128MM C/C | 5 9/16" L



37381-G10
160MM C/C | 6 13/16" L



36783-G10
192MM C/C | 8 1/8" L



36780-G10
1 1/14" DIA | 1 1/16" PROJ

FACTOR



GLACIO

AVAILABLE FINISHES



36659-CBBZ
3" C/C | 4 9/16" L

36654-CBBZ
3 3/4" C/C | 5 5/16" L

36655-CBBZ
5 1/16" C/C | 6 9/16" L

36656-CBBZ
6 5/16" C/C | 7 7/8" L

36661-CBBZ
8" C/C | 9 9/16" L



36651-CBBZ
1 3/4" L | 1 3/16" PROJ



36652-CBBZ
1 3/8" L | 1" PROJ



36653-CBBZ
1 3/8" L | 5/16" PROJ

GRACE REVITALIZE

AVAILABLE FINISHES



36628-BBZ
1 3/8" DIA
1 3/16" PROJ



36629-BBZ
1 3/4" DIA
1 3/8" PROJ

GRANBY

AVAILABLE FINISHES



53013-ORB
3" C/C | 3 3/8" L



55243-ORB
96MM C/C | 4 1/5" L



55244-ORB
128MM C/C | 5 1/2" L



55245-ORB
160MM C/C | 6 7/8" L

AVAILABLE FINISHES



55311-PN
35MM L | 1 1/7" PROJ



55312-PN
28MM DIA | 1 1/5" PROJ



55315-PN
1 3/8" L
1 5/16" PROJ
ONLY AVAILABLE IN: DOB, PN



55316-PN
3" C/C | 4 1/3" L



55317-PN
96MM C/C | 5 1/6" L



55319-PN
128MM C/C | 6 2/3" L



55321-PN
160MM C/C | 8 4/7" L



55323-PN
12" C/C | 15 1/3" L



55324-PN
18" C/C | 20 7/8" L



55318-PN
3 1/2" C/C | 4" L



INSPIRATIONS



1586-ORB
1 3/8" DIA
1" PROJ



FB ORB G10



1586-2-ORB
1 3/4" DIA
1 1/4" PROJ



FB ORB G10



1590-ORB
3" C/C | 5 5/8" L



FB ORB CZ G10 26



1587-ORB
96MM C/C | 6 5/16" L



FB ORB CZ G10 26



1593-CZ
1 7/8" L | 1 1/16" PROJ



CZ



1592-ORB
3" C/C | 4 1/4" L



FB ORB CZ G10



1588-ORB
128MM C/C | 7 1/2" L



FB ORB CZ G10 26

KAMARI

AVAILABLE FINISHES



MB GM BBZ G10 PN



36822-MB
3 3/4" C/C | 4 15/16" L



36823-MB
5 1/16" C/C | 6 3/16" L



36824-MB
6 5/16" C/C | 7 7/16" L



36825-MB
7 9/16" C/C | 8 3/4" L



36826-MB
10 1/16" C/C | 11 1/4" L



36820-MB
1 3/16" DIA | 1" PROJ



36821-MB
1 3/16" DIA | 1" PROJ

AVAILABLE FINISHES



53801-PN
96MM C/C | 4 1/3" L



53701-PN
3" C/C | 3 5/8" L



53702-PN
96MM C/C | 4 1/2" L



53802-PN
128MM C/C | 5 3/4" L



53803-PN
160MM C/C | 7" L



53805-PN
12" C/C | 13" L



53806-PN
18" C/C | 19 1/4" L



53700-PN
1 1/4" DIA | 1 1/4" PROJ



53807-2-PN
1 5/8" DIA | 1 1/2" PROJ



LONDON

AVAILABLE FINISH



- 

36647-BBRG10
1 1/2" L | 1 9/16" PROJ
- 

36648-BBRG10
3 3/4" C/C | 6 5/16" L
- 

36649-BBRG10
5 1/16" C/C | 7 1/2" L
- 

36650-BBRG10
6 5/16" C/C | 8 3/4" L
- 

36663-BBRG10
8" C/C | 10 7/16" L
- 

36664-BBRG10
10 1/16" C/C | 12 1/2" L

MERGENCE

AVAILABLE FINISHES



- 

37385-FBG10
76MM C/C | 4 1/8" L
- 

36858-FBG10
96MM C/C | 4 15/16" L
- 

36859-FBG10
128MM C/C | 6 3/16" L
- 

36860-FBG10
160MM C/C | 7 7/16" L
- 

36861-FBG10
224MM C/C | 9 15/16" L
- 

36857-FBG10
1 3/8" DIA | 1" PROJ

AVAILABLE FINISHES



36578-ORB
76MM C/C | 3 3/8" L



36570-ORB
96MM C/C | 4 1/8" L



36571-ORB
128MM C/C | 5 7/16" L



36572-ORB
160MM C/C | 6 11/16" L



36908-ORB
192MM C/C | 7 15/16" L



36909-ORB
224MM C/C | 9 13/16" L



36910-ORB
256MM C/C | 10 7/16" L



36911-ORB
320MM C/C | 13" L



54045-ORB
12" C/C | 12 11/16" L



54046-ORB
18" C/C | 18 11/16" L



36905-ORB
1 3/16" DIA | 1" PROJ



MULHOLLAND

AVAILABLE FINISHES



53030-BBZ
3" C/C | 3 3/4" L



53031-BBZ
96MM C/C | 4 9/16" L



53529-BBZ
128MM C/C | 5 7/8" L



53530-BBZ
160MM C/C | 7 1/8" L



53535-BBZ
203MM C/C | 8 7/8" L



53536-BBZ
256MM C/C | 11" L



53537-BBZ
320MM C/C | 13 1/2" L



53532-BBZ
12" C/C | 13 1/4" L



53533-BBZ
18" C/C | 19 1/4" L



53029-BBZ
1 1/4" L | 1 1/8" PROJ



535342-BBZ
1 1/2" L | 1 1/8" PROJ

NATURE'S SPLENDOR

AVAILABLE FINISHES



1581-ORB
1 1/4" DIA
1 1/8" PROJ



1580-ORB
3" C/C | 5 5/8" L

OBERON



36603-PN
1 3/8" DIA
1 3/16" PROJ



MB GM CZ BBZ G10 PN



36608-PNFA
1 3/8" DIA
1 3/16" PROJ



MBFA GMFA CZFA BBZFA G10FA PNFA



36604-PN
1 3/4" DIA
1 5/16" PROJ



GM BBZ G10 PN



36609-PN
1 3/4" DIA
1 5/16" PROJ



GMFA BBZFA G10FA PNFA



AVAILABLE FINISHES



BMB BMB BCR BGL BGL
BGL G10 BGL BCR G10



36681-BMBG10
3 3/4" C/C | 4 15/16" L



36682-BMBG10
5 1/16" C/C | 6 3/16" L



36683-BMBG10
6 5/16" C/C | 7 7/16" L



36684-BMBG10
8 13/16" C/C | 10" L



36680-BMBG10
2 5/8" L | 1 3/16" PROJ

OVERTON



AVAILABLE FINISHES



FB CZ G10 26



36844-CZ
96MM C/C | 4 1/4" L



36845-CZ
128MM C/C | 5 9/16" L



36846-CZ
160MM C/C | 6 13/16" L



36843-CZ
1 1/4" DIA | 1 1/16" PROJ

PREMISE





RADIUS

AVAILABLE FINISHES





- 

37390-FB
76MM C/C | 5" L
- 

36865-FB
96MM C/C | 5 3/4" L
- 

36866-FB
128MM C/C | 7 1/16" L
- 

36867-FB
160MM C/C | 8 5/16" L
- 

36868-FB
192MM C/C | 9 9/16" L
- 

36869-FB
256MM C/C | 12 1/16" L
- 

37391-FB
320MM C/C | 14 5/8" L
- 

54050-FB
12" C/C | 14 15/16" L
- 

54051-FB
18" C/C | 21" L
- 

54052-FB
24" C/C | 27" L



36864-FB
1 1/4" DIA | 1 1/16" PROJ

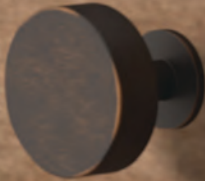

RAVINO

AVAILABLE FINISHES



21935-G10
76MM C/C | 5" L

21936-G10
96MM C/C | 5 3/4" L

21937-G10
128MM C/C | 7 1/16" L

21938-G10
160MM C/C | 8 5/16" L

22094-G10
76MM C/C | 3 11/16" L

53012-G10
1 1/4" DIA
1 1/8" PROJ



AVAILABLE FINISHES



37395-ORB
76MM C/C | 3 5/8" L

36794-ORB
96MM C/C | 4 7/16" L

36795-ORB
128MM C/C | 5 11/16" L

36796-ORB
160MM C/C | 7" L

54055-ORB
12" C/C | 13 1/16" L

54056-ORB
18" C/C | 19 5/16" L

36793-ORB
1 1/4" DIA
1 1/8" PROJ

ALSO AVAILABLE IN
BBZ

RENOVN



REVITALIZE

AVAILABLE FINISHES



55343-ORB
3" C/C | A3 11/16" L



55344-ORB
96MM C/C | 4 5/16" L



55346-ORB
128MM C/C | 5 5/8" L



55347-ORB
160MM C/C | 6 7/8" L



55351-ORB
203MM C/C | 8 9/16" L



55349-ORB
12" C/C | 13" L



55350-ORB
18" C/C | 18 7/8" L



55340-ORB
1 1/4" L | 7/8" PROJ



55342-ORB
1 1/4" DIA | 1 1/4" PROJ

REVOLVE

AVAILABLE FINISHES

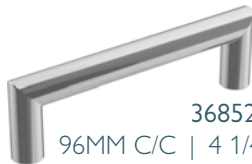

36852-26
96MM C/C | 4 1/4" L

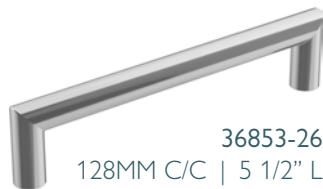

36853-26
128MM C/C | 5 1/2" L

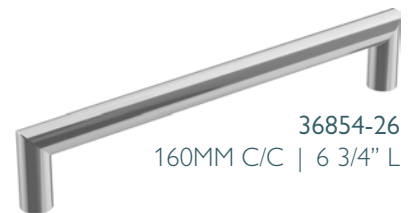

36854-26
160MM C/C | 6 3/4" L

AVAILABLE FINISHES



36899-FB
96MM C/C | 4 1/4" L



36900-FB
128MM C/C | 5 1/2" L

RIFT



AVAILABLE FINISHES



55364-GPH
3" C/C | 3 5/8" L



55365-GPH
96MM C/C | 4 7/16" L



55367-GPH
128MM C/C | 5 11/16" L



55368-GPH
160MM C/C | 7 1/16" L



55370-GPH
12" C/C | 13" L
ONLY AVAILABLE IN: GPH, G10



55371-GPH
18" C/C | 19 1/8" L
ONLY AVAILABLE IN: GPH, G10



55361-GPH
2 1/2" L
1 3/16" PROJ



55362-GPH
1 1/4" DIA
1 1/16" PROJ

RIVA

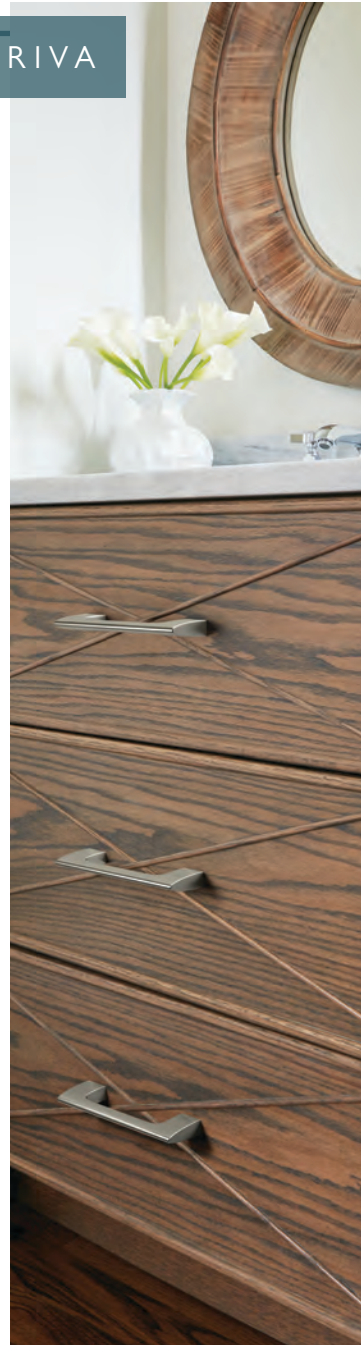

ROCHDALE

AVAILABLE FINISHES



53710-G10
1 1/4" DIA
1 1/8" PROJ



53711-G10
3" C/C | 4" L



53712-G10
96MM C/C | 4 3/4" L



53713-G10
128MM C/C | 6" L



53714-G10
160MM C/C | 7 1/4" L



53715-G10
3" C/C | 4 1/2" L



53716-G10
96MM C/C | 5 3/8" L

SEA GRASS

AVAILABLE FINISHES



36617-BBZ
1 3/4" L | 1 5/16" PROJ



36614-BBZ
1 1/2" L | 1 3/16" PROJ



36615-BBZ
3" C/C | 3 7/8" L



36621-BBZ
3 3/4" C/C | 5" L



36622-BBZ
5 1/16" C/C | 6 1/4" L



36623-BBZ
6 5/16" C/C | 7 1/2" L

SEPARA

AVAILABLE FINISHES



BBN 26



36735-BBN
160MM C/C | 8 13/16" L



36736-BBN
8" C/C | 10 1/2" L



36737-BBN
10 1/16" C/C | 12 5/8" L



AVAILABLE FINISHES



BBR ORB CZ BBZ G10 PN 26

ST. VINCENT



36646-PN
3" C/C | 5 7/16" L



36642-PN
2 1/2" L | 1 7/16" PROJ



36643-PN
3 3/4" C/C | 6 5/16" L



36644-PN
5 1/16" C/C | 7 1/2" L



36645-PN
6 5/16" C/C | 8 3/4" L



STATURE

AVAILABLE FINISHES



36891-26
76MM C/C | 3 3/4" L



36887-26
96MM C/C | 4 9/16" L

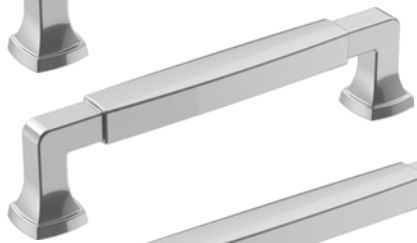

36888-26
128MM C/C | 5 13/16" L



36889-26
160MM C/C | 7 1/16" L



36890-26
224MM C/C | 9 9/16" L



37400-26
256MM C/C | 10 7/8" L



37401-26
320MM C/C | 13 7/16" L



54060-26
12" C/C | 13 1/8" L

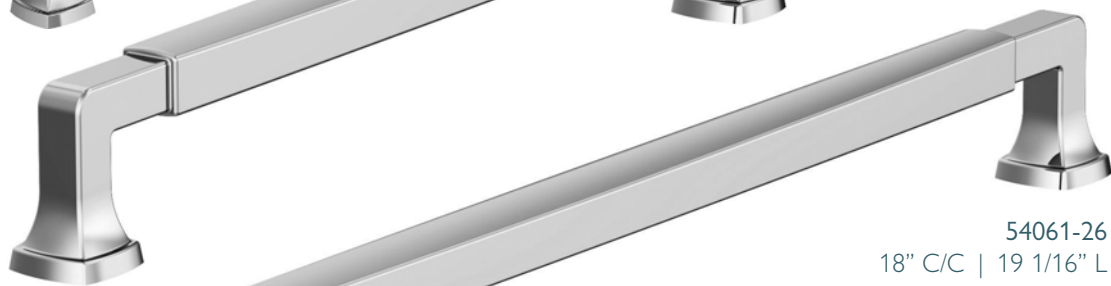

54061-26
18" C/C | 19 1/16" L



22439-26
128MM C/C | 6 3/8" L



11287-26
1 1/4" L | 1 1/4" PROJ



STATUS

AVAILABLE FINISHES



36837-MB
96MM C/C | 4 9/16" L

36838-MB
128MM C/C | 5 13/16" L

36839-MB
160MM C/C | 7 1/16" L

36840-MB
224MM C/C | 9 5/8" L



36836-MB
2" L | 1 1/16" PROJ

SURPASS

AVAILABLE FINISHES



36897-CZ
76MM C/C | 3 25/32" L

36894-CZ
96MM C/C | 4 9/16" L

36895-CZ
128MM C/C | 5 13/16" L

36896-CZ
160MM C/C | 7 1/16" L



36893-CZ
1 1/4" L | 1 3/16" PROJ

TRADITIONAL CLASSICS



55268-CBBZ
1 1/4" DIA
1 1/2" PROJ



CORB CBBR CBBZ CG10 CPN



TRANSCENDENT

AVAILABLE FINISHES



741496-MBMG
3 3/4" C/C | 6 15/16" L



7414128-MBMG
5 1/16" C/C | 8 3/16" L



7414160-MBMG
6 5/16" C/C | 9 7/16" L



7414192-MBMG
7 9/16" C/C | 10 11/16" L



7414256-MBMG
10 1/16" C/C | 13 3/16" L



UPRISE

AVAILABLE FINISHES



36917-G10
96MM C/C | 6 5/8" L



36918-G10
128MM C/C | 7 7/8" L



36919-G10
192MM C/C | 10 5/8" L



36920-G10
224MM C/C | 11 15/16" L



URBANITE

AVAILABLE FINISHES



- 

77896-BGLWHT
3 3/4" C/C | 6 1/2" L
- 

778128-BGLWHT
5 1/16" C/C | 7 13/16" L
- 

778160-BGLWHT
6 5/16" C/C | 9 1/16" L
- 

778192-BGLWHT
7 9/16" C/C | 10 1/4" L
- 

778256-BGLWHT
10 1/16" C/C | 12 3/4" L
- 

67-BGLWHT
2 5/8" L | 1 3/16" PROJ



AVAILABLE FINISHES



- 

37230-G10
76MM C/C | 3 15/16" L
- 

37231-G10
128MM C/C | 6" L
- 

53014-G10
1 3/8" L | 1 1/2" PROJ
- 

53003-G10
96MM C/C | 4 3/4" L
- 

37232-G10
160MM C/C | 7 1/4" L





VERSA

AVAILABLE FINISHES



- 

36912-FB
96MM C/C | 4 11/16" L
- 

36913-FB
128MM C/C | 5 15/16" L
- 

36914-FB
160MM C/C | 7 3/16" L
- 

36915-FB
224MM C/C | 9 3/4" L
- 

36904-FB
1 3/8" DIA | 1" PROJ



VILLE

AVAILABLE FINISHES



36775-26
96MM C/C | 4 5/8" L

36776-26
128MM C/C | 5 7/8" L

36777-26
160MM C/C | 7 1/8" L



36774-26
1 1/8" DIA | 1 1/16" PROJ

WESTERLY

AVAILABLE FINISHES



53719-BBZ
3" C/C | 4 1/4" L

53720-BBZ
96MM C/C | 5 1/16" L

53721-BBZ
128MM C/C | 6 1/4" L

53722-BBZ
160MM C/C | 7 5/8" L

54023-BBZ
12" C/C | 13 7/8" L

54024-BBZ
18" C/C | 19 15/16" L



53717-BBZ
1 5/16" L | 1 1/16" PROJ



53718-BBZ
1 3/16" DIA | 1 1/8" PROJ

AVAILABLE FINISHES



36770-CZ
76MM C/C | 4 1/2" L



36766-CZ
96MM C/C | 5 5/16" L



36767-CZ
128MM C/C | 6 1/2" L



36771-CZ
160MM C/C | 7 13/16" L



36768-CZ
192MM C/C | 9 1/16" L



36769-CZ
224MM C/C | 10 5/16" L



54065-CZ
12" C/C | 14 1/2" L



54066-CZ
18" C/C | 20 9/16" L



54067-CZ
24" C/C | 26 1/2" L



36765-CZ
1 1/4" DIA | 1 3/16" PROJ



APPOINT



AVAILABLE FINISHES



36070-G10
1 7/8" L
2 1/2" PROJ



36071-G10
7 1/16" L
2 1/2" PROJ



36072-G10
7 1/16" L
2 1/16" PROJ



36073-G10
18" C/C | 19 1/4" L

36074-G10
24" C/C | 25 1/4" L

ARRONDI



AVAILABLE FINISHES



26542-BBZ
2 1/16" L
2 1/16" PROJ



26540-BBZ
7 5/16" L
3 1/16" PROJ



26541-BBZ
6 3/8" L
2 1/16" PROJ



26546-BBZ
9" C/C | 11 5/8" L

26543-BBZ
18" C/C | 21" L

26544-BBZ
24" C/C | 27" L

BLACKROCK



AVAILABLE FINISHES



36000-ORB
3 9/16" L
2 1/8" PROJ



36001-ORB
9 5/16" L
2 13/16" PROJ



36002-ORB
6 13/16" L
2 7/8" PROJ



36003-ORB
18" C/C | 19 7/8" L

36004-ORB
24" C/C | 25 7/8" L

DAVENPORT

AVAILABLE FINISHES



36050-MB
2 15/16" L
3" PROJ



36051-MB
8 13/16" L
3" PROJ



36052-MB
5 1/4" L
3" PROJ

36053-MB
18" C/C | 20 5/16" L



36054-MB
24" C/C | 26 5/16" L



ESQUIRE

AVAILABLE FINISHES



26613-PNGM
4 1/2" L
2 9/16" PROJ



26617-PNGM
5 7/8" L
3 3/16" PROJ



26612-PNGM
5 1/4" L
2 9/16" PROJ

26614-PNGM
18" C/C | 22 11/16" L



26615-PNGM
24" C/C | 28 5/8" L



GLACIO

AVAILABLE FINISHES



36060-CCZ
2 15/16" L
2 1/2" PROJ



36061-CCZ
7 1/16" L
3 1/16" PROJ



36062-CCZ
5 7/16" L
3 1/16" PROJ

36065-CCZ
8" C/C | 10 1/4" L



36063-CCZ
18" C/C | 20 1/4" L



36064-CCZ
24" C/C | 26 1/4" L



HIGHLAND RIDGE

AVAILABLE FINISHES



36010-26
2 5/8" L
2 1/2" PROJ



36011-26
10 5/8" L
2 13/16" PROJ



36012-26
7 7/16" L
3" PROJ



36013-26
18" C/C | 20 13/16" L



36014-26
24" C/C | 26 13/16" L

MONUMENT

AVAILABLE FINISHES



36080-MB
7/8" L
2 3/8" PROJ



36081-MB
5 7/8" L
2 3/4" PROJ



36082-MB
6 1/2" L
2 3/8" PROJ



36083-MB
18" C/C | 18 7/8" L



36084-MB
24" C/C | 24 7/8" L

MULHOLLAND

AVAILABLE FINISHES



36020-G10
4 1/4" L
3 5/8" PROJ



36021-G10
8 13/16" L
2 13/16" PROJ



36022-G10
5 3/4" L
2 5/16" PROJ



36023-G10
18" C/C | 19 13/16" L



36024-G10
24" C/C | 25 3/4" L

REVITALIZE



36030-BBZ
2 1/8" L
2 3/8" PROJ



36031-BBZ
7 7/8" L
3 1/16" PROJ



36032-BBZ
6 3/8" L
2 13/16" PROJ



36033-BBZ
18" C/C | 19 3/4" L



36034-BBZ
24" C/C | 25 3/4" L



ST. VINCENT



36040-CZ
2 1/16" L
2 1/16" PROJ



36041-CZ
7 5/16" L
3 1/16" PROJ



36042-CZ
6 3/8" L
2 1/16" PROJ



36043-CZ
18" C/C | 21" L



36044-CZ
24" C/C | 26 8/9" L



STATURE



36090-G10
2 1/4" L
2 1/2" PROJ



36091-G10
7 1/16" L
2 5/8" PROJ



36092-G10
7 9/16" L
2 5/8" PROJ



36093-G10
18" C/C | 20 1/4" L



36094-G10
24" C/C | 26 1/4" L



MAGNETIC CATCHES



9765-PT
5-11 LBS PULL FORCE
1 15/16" L



9765F-PT
5-11 LBS PULL FORCE
1 15/16" L



9773-PT
5-11 LBS PULL FORCE
2" L



HINGES

AVAILABLE FINISHES



FB ORB BB CZ BBZ G10 W



7550-WI
2 1/4" L
1/2" OVERLAY

HINGES

AVAILABLE FINISHES



FB ORB CZ BBZ G10 26



7566-26
2 1/4" L
1/4" OVERLAY

HINGES

AVAILABLE FINISHES



FB ORB BB CZ BBZ G10 26



7565-G10
2 1/4" L
3/8" INSET

HINGES

AVAILABLE FINISHES



FB ORB BAE CZ BBZ G10



3175-TB-ORB
2 1/2" L

HINGES

AVAILABLE FINISHES



FB ORB CZ BBZ G10



3180-TB-FB
2 1/2" L

HINGES

AVAILABLE FINISHES



14 3 G10 BB WI ORB BK



7139-14
2 3/4" L
VARIABLE OVERLAY

HINGES

AVAILABLE FINISHES



FB BAE CZ BBZ



3175-TM-BBZ
2 7/8" L

HINGES

AVAILABLE FINISHES



FB CZ BBZ



3180-TM-CZ
2 3/4" L

HINGES

AVAILABLE FINISHES



BB G10 ORB



7128-BB
2 3/4" L
3/8" INSET

H-Select



Unit Swivels to Display Three Sides.

H-Select

Display Boards

BOARD 1



BOARD 2



BOARD 3



H-Select

H-SELECT

BOARD 12



BOARD 16



BOARD 13



BOARD 17



BOARD 14



BOARD 18

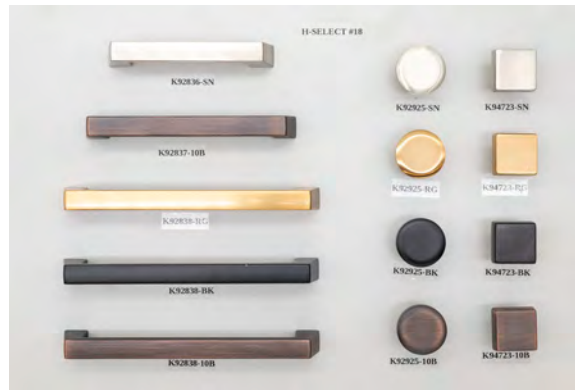

BOARD 15



BOARD 19



H-Select

COLORADO - NEW!



K92925-SN
SATIN NICKEL
1 5/16" DIA
1 1/8" PROJ



K92925-BK
MATTE BLACK
1 5/16" DIA
1 1/8" PROJ



K92925-10B
OIL RUBBED BRONZE
1 5/16" DIA
1 1/8" PROJ



K92925-RG
ROSE GOLD
1 5/16" DIA
1 1/8" PROJ



K92925-DP
DARK PEWTER
1 5/16" DIA
1 1/8" PROJ



K92925-PC
POLISHED CHROME
1 5/16" DIA
1 1/8" PROJ



K94723-SN
SATIN NICKEL
1 1/8" DIA
1 1/8" PROJ



K94723-BK
MATTE BLACK
1 1/8" DIA
1 1/8" PROJ



K94723-10B
OIL RUBBED BRONZE
1 1/8" DIA
1 1/8" PROJ



K94723-RG
ROSE GOLD
1 1/8" DIA
1 1/8" PROJ



K94723-DP
DARK PEWTER
1 1/8" DIA
1 1/8" PROJ



K94723-PC
POLISHED CHROME
1 1/8" DIA
1 1/8" PROJ

ITEM

K92836

K92837

K92838

K92925

K94723



K92836-SN
SATIN NICKEL
4 5/8" L
96MM C/C



K92836-10B
OIL RUBBED BRONZE
4 5/8" L
96MM C/C



K92836-DP
DARK PEWTER
4 5/8" L
96MM C/C



K92837-SN
SATIN NICKEL
5 7/8" L
128MM C/C



K92837-10B
OIL RUBBED BRONZE
5 7/8" L
128MM C/C



K92837-DP
DARK PEWTER
5 7/8" L
128MM C/C



K92838-SN
SATIN NICKEL
7 1/8" L
160MM C/C



K92838-10B
OIL RUBBED BRONZE
7 1/8" L
160MM C/C



K92838-DP
DARK PEWTER
7 1/8" L
160MM C/C



K92836-BK
MATTE BLACK
4 5/8" L
96MM C/C



K92836-RG
ROSE GOLD
4 5/8" L
96MM C/C



K92836-PC
POLISHED CHROME
4 5/8" L
96MM C/C



K92837-BK
MATTE BLACK
5 7/8" L
128MM C/C



K92837-RG
ROSE GOLD
5 7/8" L
128MM C/C



K92837-PC
POLISHED CHROME
5 7/8" L
128MM C/C



K92838-BK
MATTE BLACK
7 1/8" L
160MM C/C



K92838-RG
ROSE GOLD
7 1/8" L
160MM C/C



K92838-PC
POLISHED CHROME
7 1/8" L
160MM C/C

H-SELECT

STOCKPORT



K3219-96-ORB
OIL RUBBED BRONZE
4 5/8" L
96MM C/C



K3219-96-BYAB
BLACK YELLOW ANTIQUE BRASS
4 5/8" L
96MM C/C



K3219-96-BRN
BRUSHED NICKEL
4 5/8" L
96MM C/C

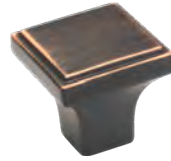

K3219-ORB
OIL RUBBED BRONZE
1 1/16" DIA
1" PROJ

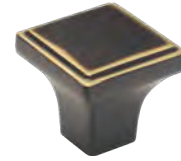

K3219-BYAB
BLACK YELLOW ANTIQUE BRASS
1 1/16" DIA
1" PROJ

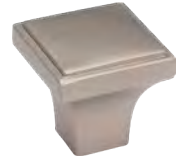

K3219-BRN
BRUSHED NICKEL
1 1/16" DIA
1" PROJ

ITEM
K3219-ORB
K3219-BYAB
K3219-BRN
K3219-96-ORB
K3219-96-BYAB
K3219-96-BRN

H-SELECT

ROWVILLE



K3235-96-BYAB
BLACK YELLOW ANTIQUE BRASS
5 1/8" L
96MM C/C



K3235-128-BYAB
BLACK YELLOW ANTIQUE BRASS
6 3/8" L
128MM C/C



K3235-96-ORB
OIL RUBBED BRONZE
5 1/8" L
96MM C/C



K3235-128-ORB
OIL RUBBED BRONZE
6 3/8" L
128MM C/C



K3235-96-BRN
BRUSHED NICKEL
5 1/8" L
96MM C/C



K3235-128-BRN
BRUSHED NICKEL
6 3/8" L
128MM C/C



K3235-96-BL
BLACK
5 1/8" L
96MM C/C



K3235-128-BL
BLACK
6 3/8" L
128MM C/C

ITEM
K3235-96-BYAB
K3235-128-BYAB
K3235-96-ORB
K3235-128-ORB
K3235-96-BRN
K3235-128-BRN
K3235-96-BL
K3235-128-BL

H-Select

CHEYENNE



K3417-ORB
OIL RUBBED BRONZE
1 1/4" DIA
1" PROJ



K3417-BB
BURNISHED BRASS
1 1/4" DIA
1" PROJ



K3417-WN
WEATHERED NICKEL
1 1/4" DIA
1" PROJ



K3417-GOLD
GOLD
1 1/4" DIA
1" PROJ

ITEM

K3417-ORB

K3417-BB

K3417-WN

K3417-GOLD

DENALI



K4618-BN
BRUSHED NICKEL
1" DIA
1 3/16" PROJ



K4618-SAB
SABLE
1" DIA
1 3/16" PROJ



K4618-HB
HONEY BRONZED
1" DIA
1 3/16" PROJ



K773-SN
SATIN NICKEL
5 1/4" L
96MM C/C



K773-SAB
SABLE
5 1/4" L
96MM C/C



K773-HB
HONEY BRONZED
5 1/4" L
96MM C/C

ITEM

K4618-BN

K4618-SAB

K4618-HB

K773-SN

K773-SAB

K773-HB

H-SELECT

INSPIRATION RING



K4118-WN
WEATHERED NICKEL
2" DIA
1 1/2" PROJ



K4118-BB
BURNISHED BRASS
2" DIA
1 1/2" PROJ



K4118-ORB
OIL RUBBED BRONZE
2" DIA
1 1/2" PROJ

ITEM

K4118-WN

K4118-BB

K4118-ORB

CLASSIC RING



K4318-BRPW
BRUSHED PEWTER
2" DIA
1" PROJ



K4318-BN
BRUSHED NICKEL
2" DIA
1" PROJ



K4318-AE
ANTIQUÉ ENGLISH
2" DIA
1" PROJ



K4318-ORB
OIL RUBBED BRONZE
2" DIA
1" PROJ

ITEM

K4318-BRPW

K4318-BN

K4318-ORB

K4318-AE

LINCOLN



K4218-BB
BURNISHED BRASS
7/8" DIA
3/4" PROJ



K4218-WN
WEATHERED NICKEL
7/8" DIA
3/4" PROJ



K4218-ORB
OIL RUBBED BRONZE
7/8" DIA
3/4" PROJ

ITEM

K4218-BB

K4218-WN

K4218-ORB

H-SELECT

MISC. KNOBS



K2302-AS
ANTIQUÉ SILVER
1 1/2" DIA
1 1/8" PROJ



K4418-BN
BRUSHED NICKEL
3/4" DIA
15/16" PROJ



K3217-DACM
DARK ANTIQUÉ
COPPER MACHINED
1 1/4" DIA
1 1/8" PROJ



K4438-WI
WROUGHT IRON
1 1/2" DIA
1 1/4" PROJ

ITEM

K2302-AS

K4418-BN

K3217-DACM

K4438-WI

BOW



K2040-BL
BLACK
1 1/4" DIA
1 1/4" PROJ



K2040-OB
OIL BRONZE
1 1/4" DIA
1 1/4" PROJ



K2040-SN
SATIN NICKEL
1 1/4" DIA
1 1/4" PROJ



K2335-OB
OIL BRONZE
1 1/4" DIA
1" PROJ



K2335-WN
WEATHERED NICKEL
1" DIA
3/4" PROJ

ITEM

K2029-ABMD

K2029-BL

K2029-LAP

K2029-OB

K2029-SN

K2040-BL

K2040-OB

K2040-SN

K2335-OB

K2335-WN



K2029-BL
BLACK
6 1/8" L
128MM C/C



K2029-LAP
LIGHT ANTIQUÉ PEWTER
6 1/8" L
128MM C/C



K2029-OB
OIL BRONZE
6 1/8" L
128MM C/C









K2029-SN
SATIN NICKEL
6 1/8" L
128MM C/C



K2029-ABMD
ANTIQUÉ BRASS MACHINED DULL
6 1/8" L
128MM C/C

AMERICANA

				ITEM
K88 LANCASTER ANTIQUE 1 1/4" DIA 3/4" PROJ	K88-B PEWTER 1 1/4" DIA 3/4" PROJ	K282-AN ANTIQUENICKEL 2 1/8" DIA 7/8" PROJ	K330-AN ANTIQUENICKEL 7/8" DIA 1 1/8" PROJ	K87
				K87-B
K87 LANCASTER ANTIQUE 4 1/8" L 3" C/C	K87-B PEWTER 4 1/8" L 3" C/C	K87-SN SATIN NICKEL 4 1/8" L 3" C/C		K87-SN
				K88
				K88-B
				K282-AN
				K330-AN

BELL IRON 1

			ITEM
K117-ABMD ANTIQUENICKEL MACHINED DULL 1 1/4" DIA 15/16" PROJ	K117-DACM DARK BRUSHED COPPER MACHINED 1 1/4" DIA 15/16" PROJ	K527-ABMD ANTIQUENICKEL MACHINED DULL 4 1/2" L 96MM C/C	K117-ABMD
			K117-DACM
K117-DBAC DARK BRUSHED ANTIQUENICKEL 1 1/4" DIA 15/16" PROJ	K117-SIM PEWTER 1 1/4" DIA 15/16" PROJ	K527-DACM DARK BRUSHED COPPER MACHINED 4 1/2" L 96MM C/C	K117-DBAC
			K117-SIM
			K527-ABMD
			K527-DACM
			K527-DBAC
			K527-SIM

BELL IRON 2

				ITEM
K6303-RG ROSE GOLD 1 3/8" DIA 1" PROJ	K6303-ABMD ANTIQUENICKEL MACHINED DULL 1 3/8" DIA 1" PROJ	K6303-DMAC DARK MACHINED ANTIQUENICKEL 1 3/8" DIA 1" PROJ	K6373-ABMD ANTIQUENICKEL MACHINED DULL 4 1/2" L • 96MM C/C	K6303-ABMD
				K6303-DACM
K6303-MB MATTE BLACK 1 3/8" DIA 1" PROJ	K6303-DACM DARK BRUSHED COPPER MACHINED 1 3/8" DIA • 1" PROJ	K6303-SIM PEWTER 1 3/8" DIA 1" PROJ	K6373-DMAC DARK MACHINED ANTIQUENICKEL 4 1/2" L • 96MM C/C	K6303-DMAC
				K6303-SIM
K6373-RG ROSE GOLD 4 1/2" L • 96MM C/C	K6373-MB MATTE BLACK 4 1/2" L • 96MM C/C	K6373-SIM PEWTER 4 1/2" L • 96MM C/C		K6303-RG
				K6303-MB
				K6373-ABMD
				K6373-DACM
				K6373-DMAC
				K6373-SIM
				K6373-DBAC
				K6373-SN
				K6373-RG
				K6373-MB

H-SELECT

H-Select

ADVANTAGE

H-SELECT



K107-AEM
ANTIQUE ENGLISH
1 1/4" DIA
1" PROJ



K107-ASM
ANTIQUE SILVER
MACHINED
1 1/4" DIA
1" PROJ



K107-DBAC
DARK BRUSHED
ANTIQUÉ COPPER
1 1/4" DIA
1" PROJ



K107-SN
SATIN NICKEL
1 1/4" DIA
1" PROJ



K3898-DBAC
DARK BRUSHED
ANTIQUÉ COPPER
1 1/8" DIA
1 1/4" PROJ



K3898-DBN
BRIGHT NICKEL
BRUSHED DULL
1 1/8" DIA
1 1/4" PROJ



K3208-DBAC
DARK BRUSHED
ANTIQUÉ COPPER
4 1/4" L
3" C/C



K3208-SN
SATIN NICKEL
4 1/4" L
3" C/C



K3108-DBAC
DARK BRUSHED
ANTIQUÉ COPPER
5 1/4" L
3" C/C



K516-ASM
ANTIQUÉ SILVER
MACHINED
5 1/2" L
3" C/C



K3108-SN
SATIN NICKEL
5 1/4" L
3" C/C



K516-SN
SATIN NICKEL
5 1/2" L
3" C/C



K516-AEM
ANTIQUÉ ENGLISH
5 1/2" L
3" C/C



K516-DBAC
DARK BRUSHED
ANTIQUÉ COPPER
5 1/2" L
3" C/C



K3899-DBN
BRIGHT NICKEL
BRUSHED DULL
5 1/4" L
3" C/C



K3899-DBAC
DARK BRUSHED
ANTIQUÉ COPPER
5 1/4" L
3" C/C

ITEM

K107-AEM

K107-ASM

K107-DBAC

K107-SN

K516-AEM

K516-ASM

K516-DBAC

K516-SN

K3108-DBAC

K3108-SN

K3208-DBAC

K3208-SN

K3898-DBAC

K3898-DBN

K3899-DBAC

K3899-DBN

BOUNTIFUL



K6102-ORB
OIL-RUBBED BRONZE
1 1/4" DIA
1 1/8" PROJ



K6102-SN
SATIN NICKEL
1 1/4" DIA
1 1/8" PROJ



K6765-ORB
OIL-RUBBED BRONZE
5" L
3" C/C



K6765-SN
SATIN NICKEL
5" L
3" C/C

ITEM

K6102-ORB

K6102-SN

K6765-ORB

K6765-SN

H-Select

BASKET WEAVE



K3062-ORB
OIL-RUBBED BRONZE
1 1/4" DIA
1" PROJ



K3062-SN
SATIN NICKEL
1 1/4" DIA
1" PROJ



K3062-SI
PEWTER
1 1/4" DIA
1" PROJ

ITEM

K3062-ORB

K3062-SI

K3062-SN

K3063-ORB

K3063-SI

K3063-SN



K3063-ORB
OIL-RUBBED BRONZE
4 3/4" L
3" C/C



K3063-SN
SATIN NICKEL
4 3/4" L
3" C/C



K3063-SI
PEWTER
4 3/4" L
3" C/C

COUNTRY TIME



K6060-DBAC
DARK BRUSHED
ANTIQUÉ COPPER
1 1/4" DIA
1 3/8" PROJ



K6060-DBN
BRIGHT NICKEL
BRUSHED DULL
1 1/4" DIA
1 3/8" PROJ



Z117-DACM
DARK BRUSHED
COPPER MACHINED
1 1/4" DIA
1" PROJ



Z117-DBN
BRIGHT NICKEL
BRUSHED DULL
1 1/4" DIA
1" PROJ



Z117-SIM
PEWTER
1 1/4" DIA
1" PROJ

ITEM

K260-DBAC

K260-DBN

K6060-DBAC

K6060-DBN

Z117-DACM

Z117-DBN

Z117-SIM



K260-DBAC
DARK BRUSHED ANTIQUÉ COPPER
3 3/4" L
3" C/C



K260-DBN
BRIGHT NICKEL BRUSHED DULL
3 3/4" L
3" C/C

HARVEST



K6464-DBAC
DARK BRUSHED
ANTIQUÉ COPPER
1 1/4" DIA
1 1/8" PROJ



K6464-SN
SATIN NICKEL
1 1/4" DIA
1 1/8" PROJ

ITEM

K6464-DBAC

K6464-SN

K6465-DBAC

K6465-SN



K6465-DBAC
DARK BRUSHED ANTIQUÉ
COPPER
5 5/8" L
3" C/C



K6465-SN
SATIN NICKEL
5 5/8" L
3" C/C

H-Select

FLAIR



K196-ACM
ANTIQUE COPPER MACHINED
2 1/4" L
1 1/4" C/C



K196-DBAC
DARK BRUSHED ANTIQUE COPPER
2 1/4" L
1 1/4" C/C



K195-ACM
ANTIQUE COPPER MACHINED
4 7/8" L
96MM C/C



K195-DBAC
DARK BRUSHED ANTIQUE COPPER
4 7/8" L
96MM C/C

ITEM
K195-ACM
K195-DBAC
K196-ACM
K196-DBAC

H-SELECT

DELGADO



K519-ABSB
ANTIQUE BRUSHED SATIN BRASS
1 1/2" L
1 1/4" PROJ



K519-DBAC
DARK BRUSHED ANTIQUE COPPER
1 1/2" L
1 1/4" PROJ



K519-DBN
BRIGHT NICKEL BRUSHED DULL
1 1/2" L
1 1/4" PROJ

ITEM	1+	25+	100+
K519-96ABSB	\$6.50	\$5.95	\$5.50
K519-96DBAC	\$6.50	\$5.95	\$5.50
K519-96DBN	\$6.50	\$5.95	\$5.50
K519-ABSB	\$3.50	\$3.20	\$2.85
K519-DBAC	\$3.50	\$3.20	\$2.85
K519-DBN	\$3.50	\$3.20	\$2.85



K519-96ABSB
ANTIQUE BRUSHED SATIN BRASS
4 1/4" L
96MM C/C



K519-96DBAC
DARK BRUSHED ANTIQUE COPPER
4 1/4" L
96MM C/C



K519-96DBN
BRIGHT NICKEL BRUSHED DULL
4 1/4" L
96MM C/C

ROCHESTER



K155-ABSB
ANTIQUE BRUSHED SATIN BRASS
1 1/8" DIA
15/16" PROJ

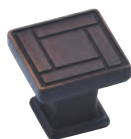

K155-DBAC
DARK BRUSHED ANTIQUE COPPER
1 1/8" DIA
15/16" PROJ



K155-DBN
BRIGHT NICKEL BRUSHED DULL
1 1/8" DIA
15/16" PROJ



K155-SN
SATIN NICKEL
1 1/8" DIA
15/16" PROJ

ITEM
K155-96ABSB
K155-96DBAC
K155-96DBN
K155-96SN
K155-ABSB
K155-DBAC
K155-DBN
K155-SN



K155-96ABSB
ANTIQUE BRUSHED SATIN BRASS
4 1/4" L
96MM C/C



K155-96DBAC
DARK BRUSHED ANTIQUE COPPER
4 1/4" L 96MM C/C



K155-96DBN
BRIGHT NICKEL BRUSHED DULL
4 1/4" L
96MM C/C



K155-96SN
SATIN NICKEL
4 1/4" L 96MM C/C

H-Select

BALANCE



K2980-AB
ANTIQUE ENGLISH
1 1/4" DIA
1 1/8" PROJ



K2980-DACM
DARK BRUSHED
COPPER MACHINED
1 1/4" DIA
1 1/8" PROJ



K2980-SN
SATIN NICKEL
1 1/4" DIA
1 1/8" PROJ



K2980-DBAC
DARK BRUSHED
ANTIQUÉ COPPER
1 1/4" DIA
1 1/8" PROJ



K2980-ORB
OIL-RUBBED
BRONZE
1 1/4" DIA
1 1/8" PROJ



K2981-AB
ANTIQUE ENGLISH
3 3/4" L
3" C/C



K2981-DACM
DARK BRUSHED COPPER MACHINED
3 3/4" L
3" C/C



K2981-DBAC
DARK BRUSHED ANTIQUÉ COPPER
3 3/4" L
3" C/C



K2981-SN
SATIN NICKEL
3 3/4" L
3" C/C



K2981-ORB
OIL-RUBBED BRONZE
3 3/4" L
3" C/C

ITEM

K2980-AB

K2980-DACM

K2980-DBAC

K2980-ORB

K2980-SN

K2981-AB

K2981-DACM

K2981-DBAC

K2981-ORB

K2981-SN

H-SELECT

CLARK

ZINC DIE CAST



K801-B
PEWTER
1 1/8" DIA
1 1/8" PROJ



K800-SN
SATIN NICKEL
1 1/8" DIA
1 1/8" PROJ



K802-AE
ANTIQUÉ ENGLISH
1 1/8" DIA
1 1/8" PROJ



K803-BI
BLACK IRON
1 1/8" DIA
1 1/8" PROJ



K810-MB
MATTE BLACK
1 1/8" DIA
1 1/8" PROJ



K804-B
PEWTER
3 3/4" L
3" C/C



K805-SN
SATIN NICKEL
3 3/4" L
3" C/C



K806-AE
ANTIQUÉ ENGLISH
3 3/4" L
3" C/C



K807-BI
BLACK IRON
3 3/4" L
3" C/C



K811-MB
MATTE BLACK
3 3/4" L
3" C/C

ITEM

K800-SN

K801-B

K802-AE

K803-BI

K804-B

K805-SN

K806-AE

K807-BI

K810-MB

K811-MB

BAR PULLS

H-SELECT



K1001
BRUSHED NICKEL 1 9/16" L
1 3/8" PROJ



K1000
BRUSHED NICKEL
4 1/2" L
76MM C/C



K1002
BRUSHED NICKEL
5 5/16" L
96MM C/C



K1003
BRUSHED NICKEL
6 5/8" L
128MM C/C



K1004
BRUSHED NICKEL
7 7/8" L
160MM C/C



K1005
BRUSHED NICKEL
9 1/8" L
192MM C/C



K1006
BRUSHED NICKEL
10 3/8" L
224MM C/C



K1007
BRUSHED NICKEL
11 5/8" L
256MM C/C



K1008
BRUSHED NICKEL
12 7/8" L
288MM C/C



K1009
BRUSHED NICKEL
14 3/16" L
320MM C/C



K1010
BRUSHED NICKEL
15 7/16" L
352MM C/C

ITEM

K1000

K1001

K1002

K1003

K1004

K1005

K1006

K1007

K1008

K1009

K1010

H-Select

SLEEK & MODERN



K1216-SN
SATIN NICKEL
7/8" DIA
1" PROJ



K426-SN
SATIN NICKEL
7/8" DIA
1" PROJ



K26-SN
SATIN NICKEL
1" DIA
15/16" PROJ



K8026-SN
SATIN NICKEL
1 3/4" L
3/4" PROJ



K515-SN
SATIN NICKEL
1 1/8" DIA
1" PROJ



D2753-SN
SATIN NICKEL
1 5/16" L
1 1/8" PROJ



K790-SN
SATIN NICKEL
1" DIA
1" PROJ



Z259-BL
BLACK
3 3/8" L
3" C/C



Z259-SN
SATIN NICKEL
3 3/8" L
3" C/C



K400-SN
SATIN NICKEL
4" L
3" C/C



K475-SN
SATIN NICKEL
4 3/4" L
96MM C/C



K3489-SN
SATIN NICKEL
4 1/2" L
3" C/C



K3489-MB
MATTE BLACK
4 1/2" L
3" C/C



K272-BL
BLACK
4 5/8" L
96MM C/C



K4690-SN
SATIN NICKEL
4 3/4" L
96MM C/C



K961-DSN
SATIN NICKEL
4 3/4" L
3" CC



K272-SN
SATIN NICKEL
4 5/8" L
96MM C/C



K2017-SN
SATIN NICKEL
5" L
96MM C/C



K4655-SN
SATIN NICKEL
6 1/4" L
5" C/C



K2017-BL
BLACK
5" L
96MM C/C



K4655-BLK
BLACK
6 1/4" L
5" C/C



K4655-AB
ANTIQUE ENGLISH
6 1/4" L
5" C/C



K5319-SN
SATIN NICKEL
14 1/8" L
12 1/2" C/C

ITEM

D2753-SN

K26-SN

K272-BL

K272-SN

K400-SN

K426-SN

K475-SN

K515-SN

K790-SN

K961-DSN

K1216-SN

K2017-BL

K2017-SN

K3489-MB

K3489-SN

K4655-AB

K4655-BLK

K4655-SN

K4690-SN

K5319-SN

K8026-SN

Z259-BL

Z259-SN

H-SELECT

H-Select

GLENDALE



K525-DBAC
DARK BRUSHED ANTIQUE
COPPER
1 1/16" SQ
1" PROJ



K525-DMAC
DARK MACHINED ANTIQUE
COPPER
1 1/16" SQ
1" PROJ

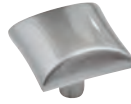

K525-SN
SATIN NICKEL
1 1/16" SQ
1" PROJ

ITEM

K525-96DBAC

K525-96DMAC

K525-96SN

K525-DBAC

K525-DMAC

K525-SN



K525-96DBAC
DARK BRUSHED
ANTIQUÉ COPPER
5" L
96MM C/C



K525-96DMAC
DARK MACHINED
ANTIQUÉ COPPER
5" L
96MM C/C



K525-96SN
SATIN NICKEL
5" L
96MM C/C

H-SELECT

KINGSPORT



K150-LP
LANCASTER ANTIQUE
2 7/8" X 4 1/4"
3" C/C

ITEM

K150-LP

WHEAT



DRAWER BAIL PULL
K200-LP
LANCASTER ANTIQUE
2 5/8" X 4 1/2"
3" C/C



KNOB
K204-LP
LANCASTER ANTIQUE
1 1/4" DIA
1 1/4" PROJ



BAR HANDLE
K205-LP
LANCASTER ANTIQUE
4 1/4" L
3" C/C

ITEM

K200-LP

K204-LP

K205-LP

OLD ENGLISH



K152-AE
ANTIQUÉ ENGLISH
4 3/4" L
3" C/C



K706-AE
ANTIQUÉ ENGLISH
4 7/8" L
3" C/C



K707-AE
ANTIQUÉ ENGLISH
4 1/4" L
2 1/2" C/C

ITEM

K152-AE

K706-AE

K707-AE

LAFAYETTE



K417-ABSB
ANTIQUE BRUSHED SATIN BRASS
1 3/8" DIA
1 1/4" PROJ



K417-DBAC
DARK BRUSHED ANTIQUE COPPER
1 3/8" DIA
1 1/4" PROJ



K417-DBN
BRIGHT NICKEL BRUSHED DULL
1 3/8" DIA
1 1/4" PROJ



K517-ABSB
ANTIQUE BRUSHED SATIN BRASS
1 3/8" DIA
1 1/4" PROJ



K517-DBAC
DARK BRUSHED ANTIQUE COPPER
1 3/8" DIA
1 1/4" PROJ



K517-DBN
BRIGHT NICKEL BRUSHED DULL
1 3/8" DIA
1 1/4" PROJ



K317-96ABSB
ANTIQUE BRUSHED SATIN BRASS
4 3/8" L
96MM C/C



K317-96DBAC
DARK BRUSHED ANTIQUE COPPER
4 3/8" L
96MM C/C



K317-96DBN
BRIGHT NICKEL BRUSHED DULL
4 3/8" L
96MM C/C

ITEM
K317-96ABSB
K317-96DBAC
K317-96DBN
K417-ABSB
K417-DBAC
K417-DBN
K517-ABSB
K517-DBAC
K517-DBN

RICHELIEU



KNOB
K147-AE
ANDOVER ANTIQUE
1 3/8" L
1 1/8" PROJ



BACKPLATE
K105-AE
ANDOVER ANTIQUE
1" X 4 1/8"

ITEM
K105-AE
K147-AE

ANTIQUE ENGLISH



A76209-AE
ANTIQUE ENGLISH
1 1/8" DIA
1" PROJ



D89-AE
ANTIQUE ENGLISH
3/4" DIA
5/8" PROJ



D89-BL
BLACK
3/4" DIA
5/8" PROJ



K208-AE
ANTIQUE ENGLISH
1 1/8" DIA
3/4" PROJ



K157-AE
ANTIQUE ENGLISH
4 3/4" L
3" C/C



K703-AE
ANTIQUE ENGLISH
5 1/2" L



K763-AE
ANTIQUE ENGLISH
5 3/8" L
3" C/C



K3208-AE
ANTIQUE ENGLISH
4 1/4" L
3" C/C



K156-AE
ANTIQUE ENGLISH
4 1/2" L
3" C/C

ITEM
A76209-AE
D89-AE
D89-BL
K156-AE
K157-AE
K208-AE
K3208-AE
K703-AE
K763-AE

H-Select

CHIPPENDALE

H-SELECT



K1461-AE
SOLID BRASS WITH ANTIQUE
ENGLISH FINISH
2 1/4" X 3 3/16"
2" C/C



K1461-PB
SOLID BRASS WITH POLISHED
BRASS FINISH
2 1/4" X 3 3/16"
2" C/C



K1462-AE
SOLID BRASS WITH ANTIQUE
ENGLISH FINISH
2 3/4" X 3 3/4"
2 1/2" C/C



K1462-PB
SOLID BRASS WITH POLISHED
BRASS FINISH
2 3/4" X 3 3/4"
2 1/2" C/C



K1463-AE
SOLID BRASS WITH ANTIQUE
ENGLISH FINISH
3 3/8" X 4 1/2"
3" C/C



K1463-PB
SOLID BRASS WITH POLISHED
BRASS FINISH
3 3/8" X 4 1/2"
3" C/C



K1464-AE
SOLID BRASS WITH ANTIQUE
ENGLISH FINISH
2 1/4" X 3 1/8"



K1464-PB
SOLID BRASS WITH POLISHED
BRASS FINISH
2 1/4" X 3 1/8"

ITEM
K1461-AE
K1461-PB
K1462-AE
K1462-PB
K1463-AE
K1463-PB
K1464-AE
K1464-PB

NEW IMPORTS ANTIQUE ENGLISH



80176-AE
PULL
81177-AE
BACKPLATE
3" C/C
4 1/4" L



80223-AE
3" C/C
5 1/4" L



80859-AE
ANTIQUE ENGLISH
5" L
3" C/C



80644-AE
3" C/C
5" L

ITEM
80644-AE
80223-AE
80859-AE
80176-AE
80177-AE

H-Select

STICKLEY MISSION II

ZINC DIE CAST



D924-AC
ANTIQUE COPPER
3 3/4" X 1"
3" C/C



D924-AE
ANTIQUE ENGLISH
3 3/4" X 1"
3" C/C



D924-BL
BLACK
3 3/4" X 1"
3" C/C



D925-AC
ANTIQUE COPPER
1 5/8" X 3 1/2"
3" C/C



D925-AE
ANTIQUE ENGLISH
1 5/8" X 3 1/2"
3" C/C



D925-BL
BLACK
1 5/8" X 3 1/2"
3" C/C

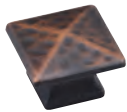

D942-AC
ANTIQUE COPPER
1 1/4" SQ
7/8" PROJ

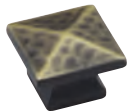

D942-AE
ANTIQUE ENGLISH
1 1/4" SQ
7/8" PROJ

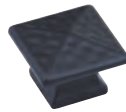

D942-BL
BLACK
1 1/4" SQ
7/8" PROJ

ITEM

D924-AC

D924-AE

D924-BL

D925-AC

D925-AE

D925-BL

D942-AC

D942-AE

D942-BL

H-SELECT

PERIOD MISSION



D552-AC
ANTIQUE COPPER
4 1/2" X 1 1/4"
3" C/C



D552-BL
BLACK
4 1/2" X 1 1/4"
3" C/C



D552-ORB
OIL-RUBBED BRONZE
4 1/2" X 1 1/4"
3" C/C

ITEM

D552-AC

D552-BL

D552-ORB

D553-AC

D553-BL

D553-ORB



D553-AC
ANTIQUE COPPER
1 1/4" X 4 1/2"
3" C/C



D553-BL
BLACK
1 1/4" X 4 1/2"
3" C/C



D553-ORB
OIL-RUBBED BRONZE
1 1/4" X 4 1/2"
3" C/C

TRADITIONAL MISSION

HEAVY DUTY BAILS



D527-A
BLACK
3 3/4" X 1"
2 1/4" C/C



D527-AE
ANTIQUE ENGLISH
3 3/4" X 1"
2 1/4" C/C



D527-B
PEWTER
3 3/4" X 1"
2 1/4" C/C



D528-A
BLACK
1 3/4" X 2 3/4"
1 1/8" C/C



D528-AE
ANTIQUE ENGLISH
1 3/4" X 2 3/4"
1 1/8" C/C



D528-B
PEWTER
1 3/4" X 2 3/4"
1 1/8" C/C



D529-A
BLACK
2" X 3 3/4"
3" C/C



D529-AE
ANTIQUE ENGLISH
2" X 3 3/4"
3" C/C



D529-B
PEWTER
2" X 3 3/4"
3" C/C

ITEM
D527-A
D527-AE
D527-B
D528-A
D528-AE
D528-B
D529-A
D529-AE
D529-B

H-SELECT

REFINED MISSION



D523-BL
BLACK
1 1/8" DIA
1" PROJ



D523-SN
SATIN NICKEL
1 1/8" DIA
1" PROJ



D523-W
WROUGHT IRON
1 1/8" DIA
1" PROJ



D521-BL
BLACK
4 1/16" L
3" C/C



D521-SN
SATIN NICKEL
4 1/16" L
3" C/C



D521-W
WROUGHT IRON
4 1/16" L
3" C/C



HH4424-BL
BLACK
4" L
3" C/C



HH4425-BL
BLACK
1 1/4" DIA
1 1/8" PROJ

ITEM
D521-BL
D521-SN
D521-W
D523-BL
D523-SN
D523-W
HH4424-BL
HH4425-BL

STICKLEY MISSION I

SOLID BRASS
PYRAMID HEAD SCREW (INCLUDED)



D526
BRASS
3 3/4" X 1 1/4"



D526-BL
BLACK IRON
3 3/4" X 1 1/4"



D526-AE
ANTIQUE ENGLISH
3 3/4" X 1 1/4"



D525
BRASS
1 1/2" X 3 1/8"

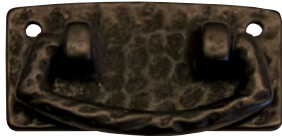

D525-BL
BLACK IRON
1 1/2" X 3 1/8"



D525-AE
ANTIQUE ENGLISH
1 1/2" X 3 1/8"

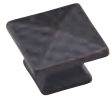

D542-AC
ANTIQUÉ COPPER
1 3/16" SQ
7/8" PROJ

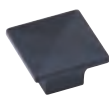

D522-BL
BLACK
1 1/4" SQ
7/8" PROJ



D524-BI
BLACK CAST IRON
1 1/8" SQ
7/8" PROJ

ITEM

D522-BL

D524-BI

D525

D525-AE

D525-BL

D526

D526-AE

D526-BL

D542-AC

HAMMERED MISSION



D550
ANTIQUÉ COPPER
1 3/4" X 3 1/2"
3" C/C



D550-A
BLACK
1 3/4" X 3 1/2"
3" C/C

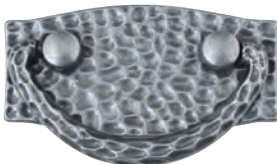

D550-B
PEWTER
1 3/4" X 3 1/2"
3" C/C



D551
ANTIQUÉ COPPER
3 1/2" X 1 3/4"



D551-B
PEWTER
3 1/2" X 1 3/4"

ITEM

D550

D550-A

D550-B

D551

D551-B

ELEGANT ART



D560-AP
ANTIQUÉ PEWTER
1 1/4" X 3 3/4"
2 1/8" C/C



D561-AP
ANTIQUÉ PEWTER
3 3/4" X 1 1/4"

ITEM

D560-AP

D561-AP

LIBERTY MISSION



K8005
BLACK IRON
1 1/2" X 4 7/8"
4 1/4" C/C



K8006
BLACK IRON
4 7/8" X 1 1/2"
4 1/4" C/C

ITEM

K8005

K8006

BIRDCAGE



K1350-DACM
DARK BRUSHED
COPPER MACHINED
2 1/4" L
1 3/8" PROJ



K1350-SIM
PEWTER
2 1/4" L
1 3/8" PROJ

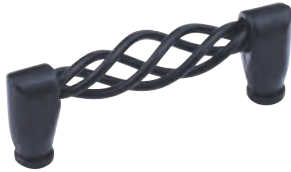

K1300-DACM
DARK BRUSHED
COPPER MACHINED
3 1/2" L
3" C/C



K1300-SIM
PEWTER
3 1/2" L
3" C/C

ITEM

K1300-DACM

K1300-SIM

K1350-DACM

K1350-SIM

IRON FORGE



K58-BL
MATTE BLACK
1 1/2" L
1 1/4" PROJ



K558-BL
MATTE BLACK
6" L
96MM C/C



K58-SI
SWEDISH IRON
1 1/2" L
1 1/4" PROJ



K558-SI
SWEDISH IRON
6" L
96MM C/C

ITEM

K58-BL

K58-SI

K462-BL

K462-SIM

K558-BL

K558-SI

K469-BL

K469-SIM



K469-BL
MATTE BLACK
" L
MM C/C



K469-SIM
PEWTER
" L
MM C/C



K462-BL
MATTE BLACK
4 5/8" L
96MM C/C



K462-SIM
PEWTER
4 5/8" L
96MM C/C

OLD WORLD



K530-W
WINDOVER ANTIQUE
1 3/4" X 1 1/4"
1 1/4" PROJ



K089-W
WROUGHT IRON
4 3/4" L
3 5/8" C/C



K570-W
WROUGHT IRON
1" DIA
3/4" PROJ



K3248-W
WROUGHT IRON
1" DIA
7/8" PROJ



K1814-W
WROUGHT IRON
3/4" DIA
3/4" PROJ



K3222-W
WROUGHT IRON
1 7/8" X 1 7/16"
5/8" PROJ

ITEM

K089-W

K530-W

K570-W

K1814-W

K3222-W

K3248-W

H-Select

RUSTIC



K3272-DACM
DARK BRUSHED
COPPER MACHINED
1 3/16" L
1 1/4" PROJ



K3031-DACM
DARK BRUSHED COPPER MACHINED
2" DIA
1 1/8" PROJ



K3273-DACM
DARK BRUSHED
COPPER MACHINED
4 1/2" L
96MM C/C



K4240-96-BL
BLACK
4 1/2" L
96MM C/C



K4240-128-BL
BLACK
5 3/4" L
128MM C/C



BHIM8900-5-BL
BLACK
6 1/4" L
5" C/C



BHIM8900-12-BL
BLACK
13" L
11 15/16" C/C

ITEM
K3031-DACM
K3272-DACM
K3273-DACM
K4240-96-BL
K4240-128-BL
BHIM8900-5-BL
BHIM8900-12-BL

H-SELECT

TRANQUIL



K5302-AB
ANTIQUÉ BRASS/ WHITE
1 1/4" DIA
1" PROJ



K5302-AB-O
ANTIQUÉ BRASS/ OAK
1 1/4" DIA
1" PROJ



K5302-PB
POLISHED BRASS/ WHITE
1 1/4" DIA
1" PROJ



K5302-PB-O
POLISHED BRASS/ OAK
1 1/4" DIA
1" PROJ



P226
OATMEAL
1 1/4" DIA
7/8" PROJ



P220
WHITE
1" DIA
1" PROJ



P225
WHITE
1 1/4" DIA
7/8" PROJ

ITEM
K5302-AB
K5302-AB-O
K5302-PB
K5302-PB-O
K5312-AB
K5312-AB-O
K5312-PB
K5312-PB-O
P220
P225
P226



K5312-AB
ANTIQUÉ BRASS/ WHITE
5" L
3" C/C



K5312-AB-O
ANTIQUÉ BRASS/ OAK
5" L
3" C/C



K5312-PB
POLISHED BRASS/ WHITE
5" L
3" C/C



K5312-PB-O
POLISHED BRASS/ OAK
5" L
3" C/C

H-Select

PALISADE



K3211-PB
BRASS PLATED
4 7/8" L
3" C/C



K3211-SN
SATIN NICKEL
4 7/8" L
3" C/C



K2910-SN
SATIN NICKEL
4 7/8" L
3" C/C

ITEM
K3211-PB
K3211-SN
K2910-SN

H-SELECT

WILLOW



K329-LP
LANCASTER ANTIQUE
3" X 4"
3" C/C



K8018-LP
LANCASTER ANTIQUE
1 7/8" X 1 1/2"



K321-LP
LANCASTER ANTIQUE
1 1/8" L
1" PROJ



BACKPLATE
K326-LP
LANCASTER ANTIQUE
1" X 5 1/2"

ITEM
K321-LP
K326-LP
K329-LP
K8018-LP

SOLID BRASS



K6641-SN
SATIN NICKEL
3/4" DIA
3/4" PROJ



K6640
POLISHED BRASS
5/8" DIA
5/8" PROJ



K6641
POLISHED BRASS
3/4" DIA
3/4" PROJ



K6641-A
BLACK
3/4" DIA
3/4" PROJ

ITEM
K15
K1884
K1908
K38
K39
K6640
K6641
K6641-A
K6641-SN



MOCK KEY
K1884
POLISHED BRASS
1 1/8" L
1" PROJ



K1908
POLISHED BRASS
4" X 4"
3" C/C



K15
POLISHED BRASS
4" L
3" C/C



K38
POLISHED BRASS
3/4" X 5 1/4"



BACKPLATE
K39
POLISHED BRASS
7/8" X 6 3/4"

MOCK KEY
K1884
POLISHED BRASS
1 1/8" L
1" PROJ

SHAKER KNOBS

- COMES WITH INSERTS
- END GRAIN



KR15-OAK
OAK
KR15-C
CHERRY
KR15-M
MAPLE
KR15-W
WALNUT
1 1/16" DIA
1 1/16" PROJ



KR15-BL
BLACK PAINT
1 1/16" DIA
1 1/16" PROJ

ITEM
KR15-OAK
KR15-BL
KR15-C
KR15-M
KR15-W

ORDER SCREWS SEPARATELY

- COMES WITH INSERTS
- USE 8/32 BOLTS



K49-D
OAK
1 3/4" SQ

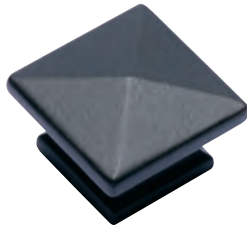

K49-B
OAK
1 1/4" SQ
K49-BC
CHERRY
1 1/4" SQ
K52-B
WALNUT
1 1/4" SQ
K53-BL
BLACK
1 1/4" SQ

ITEM
K49-B
K49-BC
K49-D
K52-B
K53-BL

ORDER SCREWS SEPARATELY

- COMES WITH INSERTS
- USE 8/32 BOLTS



K50-B
OAK
1 1/4" SQ
K51-B
CHERRY
1 1/4" SQ
K54-B
MAPLE
1 1/4" SQ



K50-C
OAK
1 1/2" SQ
K51-C
CHERRY
1 1/2" SQ
K54-C
MAPLE
1 1/2" SQ

ITEM
K49-H
K50-B
K50-C
K51-B
K51-C
K54-B
K54-C



K49-H
OAK
3" C/C

PREMIUM MISSION

WOOD KNOBS I

- COMES WITH INSERTS
- FACE GRAIN
- USE 8/32 BOLTS



K40-A
OAK
1" DIA

K45-A
CHERRY
1" DIA

K47-A
OAK
1" DIA

K41-A
BEECH
1" DIA

K46-A
WALNUT
1" DIA



K40-B
OAK
1 1/4" DIA



K47-B
OAK
1 1/4" SQ



K40-C
OAK
1 1/2" DIA



K47-C
OAK
1 1/2" SQ

K41-B
BEECH
1 1/4" DIA

K48-B
CHERRY
1 1/4" SQ

K41-C
BEECH
1 1/2" DIA

K44-B
HICKORY
1 1/4" DIA

K45-C
CHERRY
1 1/2" DIA

K45-B
CHERRY
1 1/4" DIA

K46-C
WALNUT
1 1/2" DIA

K46-B
WALNUT
1 1/4" DIA

K55-C
MAPLE
1 1/2" DIA

K55-B
MAPLE
1 1/4" DIA

K56-C
QTR. SAWN W. OAK
1 1/2" DIA

K56-B
QTR. SAWN W. OAK
1 1/4" DIA

K57-B
GRAY ELM
1 1/4" DIA

ITEM

K40-A

K40-B

K40-C

K41-A

K41-B

K41-C

K44-B

K45-A

K45-B

K45-C

K46-A

K46-B

K46-C

K47-A

K47-B

K47-C

K48-B

K55-B

K55-C

K56-B

K56-C

K57-B

ORDER SCREWS SEPARATELY

H-SELECT

WOOD KNOBS II

- COMES WITH INSERTS
- FACE GRAIN



OVAL SHAPED WOOD KNOB

K114-M
MAPLE
1 7/8" X 1 1/2"
1 1/16" PROJ

K114-O
OAK
1 7/8" X 1 1/2"
1 1/16" PROJ

ITEM

K114-O

K114-M

ORDER SCREWS SEPARATELY

WOOD KNOBS IV



K4275
OAK
1 3/8" DIA



K4277
OAK
1 3/4" DIA



K4278
OAK
2" DIA

K4375
WALNUT
1 3/8" DIA

K4377
WALNUT
1 3/4" DIA

K4378
WALNUT
2" DIA

ITEM

K4275

K4277

K4278

K4375

K4377

K4378

ORDER SCREWS SEPARATELY



BBW1
OAK
5 1/2" C/C, 7" W X 1 3/8" H



BBW8
OAK
3 3/4" C/C, 4 1/2" W X 7/8" H



BBW2
OAK
3 1/2" C/C, 5" W X 1 3/8" H



BBW9
OAK
3 3/4" C/C, 4 1/4" W X 1 3/4" H
BBW9-A
CHERRY
3 3/4" C/C, 4 1/4" W X 1 3/4" H

BBW2-A
CHERRY
3 1/2" C/C, 5" W X 1 3/8" H

ITEM
BBW1
BBW2
BBW2-A
BBW4
BBW5
BBW5-A
BBW8
BBW9
BBW9-A
BBW12
BBW15

ORDER SCREWS SEPARATELY



BBW4
OAK
5 1/2" C/C, 7" W X 1 3/8" H



BBW12
OAK
3" C/C, 5 1/2" W



BBW5
OAK
3 3/4" C/C, 5" W X 1 3/8" H



BBW15
OAK
5" C/C, 7 1/4" W

BBW5-A
CHERRY
3 3/4" C/C, 5" W X 1 3/8" H

HOOKS



Q15 SOLID BRASS 5" H
BASE 2" X 1 1/8"
Q15-F BLACK 5" H
BASE 2" X 1 1/8"
Q30 ANTIQUE BRASS 5" H
BASE 2 3/8" X 7/16"
Q34 BLACK 5 1/2" H
BASE 2" X 1 1/16"
Q4 SOLID BRASS 4 1/2" H
BASE 1 3/8" X 1 1/4"
Q4-F BLACK 4 1/2" H
BASE 1 3/8" X 1 1/4"

ITEM
Q15
Q15-F
Q30
Q34
Q4
Q4-F

ARTS AND CRAFTS

OLD CLASSIC

ITEM

Q351

Q351-A

Q351-B



Q351
SOLID BRASS
5 1/2" H
BASE 2 1/4" X 9/16"



Q351-A
OIL-RUBBED BRONZE
5 1/2" H
BASE 2 1/4" X 9/16"



Q351-B
SATIN NICKEL
5 1/2" H
BASE 2 1/4" X 9/16"



Q31
ANTIQUÉ BRASS
5 1/2" H
BASE 1 1/2" X 1 3/4"



Q32-BL
FLAT BLACK
5 1/2" H
BASE 1 1/2" X 1 3/4"



Q33
BRASS
5 1/2" H
BASE 1 1/2" X 1 3/4"

ITEM

Q31

Q32-BL

Q33

RETRO



Q29
BRASS
5 1/2" H
BASE 1 3/4" X 1"



Q29-AE
ANTIQUÉ ENGLISH
5 1/2" H
BASE 1 3/4" X 1"



Q29-BL
BLACK
5 1/2" H
BASE 1 3/4" X 1"



Q29-ORB
OIL-RUBBED
BRONZE
5 1/2" H
BASE 1 3/4" X 1"



Q29-SN
SATIN NICKEL
5 1/2" H
BASE 1 3/4" X 1"

ITEM

Q29

Q29-AE

Q29-BL

Q29-ORB

Q29-SN

JEWELRY HOOKS



KB3
ANTIQUÉ BRASS
1 1/2" H
BASE 1 1/4" X 5/8"



KB3-SN
SATIN NICKEL
1 1/2" H
BASE 1 1/4" X 5/8"



KB3-BL
BLACK
1 1/2" H
BASE 1 1/4" X 5/8"



Q96-BL
BLACK
1 1/2" H
BASE 1 3/8" X 3/4"



Q96-ORB
OIL-RUBBED
BRONZE
1 1/2" H
BASE 1 3/8" X 3/4"



Q96-SN
SATIN NICKEL
1 1/2" H
BASE 1 3/8" X 3/4"

ITEM

KB3

KB3-SN

KB3-BL

Q96-BL

Q96-ORB

Q96-SN

COUNTRY LATCHES



D1618-AB
ANTIQUÉ BRASS
LATCH ~ 2 1/8" X 1 1/2"
CATCH ~ 2 1/8" X 5/8"



D1618-PB
POLISHED BRASS
LATCH ~ 2 1/8" X 1 1/2"
CATCH ~ 2 1/8" X 5/8"



D1618-AC
ANTIQUÉ COPPER
LATCH ~ 2 1/8" X 1 1/2"
CATCH ~ 2 1/8" X 5/8"



D1618-PN
NICKEL
LATCH ~ 2 1/8" X 1 1/2"
CATCH ~ 2 1/8" X 5/8"



D1618-ORB
OIL-RUBBED
BRONZE
LATCH ~ 2 1/8" X 1 1/2"
CATCH ~ 2 1/8" X 5/8"

ITEM

D1618-AB

D1618-PB

D1618-AC

D1618-PN

D1618-ORB

DESK CARD HOLDERS



F1401
STAMPED BRASS
1 1/4" X 2 3/8"



F1403
STAMPED BRASS
1 1/2" X 3 1/8"



FF6
POLISHED BRASS
1" X 2 1/4"
11/16" PROJ
■ SOLID BRASS



FF6-BL
BLACK
1" X 2 1/4"
11/16" PROJ
■ SOLID BRASS



FF6-SN
SATIN NICKEL
1" X 2 1/4"
11/16" PROJ
■ SOLID BRASS

ITEM
F1401
F1403
FF6
FF6-BL
FF6-SN

GROMMETS



BG1-PB
POLISHED BRASS
2 1/2" HOLE
3" DIA



BG2-PBL
PLASTIC BLACK
2 1/2" HOLE
3" DIA



BG3-PB
POLISHED BRASS
1 9/16" HOLE
2" DIA



BG4-SN
BRUSHED NICKEL
2 1/2" HOLE
3" DIA



BG5-BL
BLACK
1 9/16" HOLE
2" DIA



BG6-SN
BRUSHED NICKEL
1 9/16" HOLE
2" DIA



BG7-O
OAK
2 1/2" HOLE
3" DIA



BG8-M
MAPLE
2 1/2" HOLE
3" DIA



BG9-BL
BLACK
2 1/2" HOLE
3" DIA

ITEM
BG1-PB
BG2-PBL
BG3-PB
BG4-SN
BG5-BL
BG6-SN
BG7-O
BG8-M
BG9-BL

KEY HOLES



E1-AE
STAMPED BRASS
1" DIA



E1-PB
STAMPED BRASS
1" DIA



E3-AE
STAMPED BRASS
1 1/8" X 1 1/2"



E3-PB
STAMPED BRASS
1 1/8" X 1 1/2"

ITEM
E1-AE
E1-PB
E3-AE
E3-PB

CHEVEL MIRROR MOUNTS I

SOLID BRASS CHEVEL MIRROR MOUNT

- INCLUDES 3 1/2" BOLTS W/ FRICTION WASHERS AND NUT

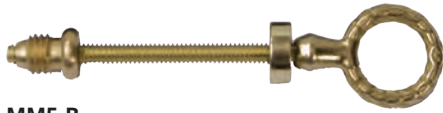

MM5-B
POLISHED BRASS

ITEM

MM5-B

CHEVEL MIRROR MOUNTS II

ZINC DIE CAST CHEVEL MIRRORS MOUNTS

- 2 1/2" BOLTS COMES W/ FRICTION WASHERS AND NUT



M6-AB
ANTIQUÉ BRASS



M6-BL
BLACK



M6-SN
SATIN NICKEL

ITEM

M6-AB

M6-BL

M6-SN

DECORATIVE HINGES - NON SELF-CLOSING

- FULL WRAP AROUND HINGE - FULL INSET
- FOR 3/4" FRAME & 3/4" DOOR, 270° OPENING
- STYLISH TIPS FOR SHAKER STYLE CABINETS WITH RAISED PANEL DOORS
- NON-MORTISE HINGE QUICKLY INSTALLS & YIELDS MINIMAL DOOR GAP
- #6 X 5/8" FLAT HEAD SCREW RECOMMENDED FOR ATTACHMENT TO FRAME AND #6 X 1/2" FLAT HEAD SCREW RECOMMENDED FOR DOOR ATTACHMENT
- SLOTTED HOLES PROVIDE HORIZONTAL & VERTICAL ADJUSTMENT



MINARET TIP FULL WRAP AROUND HINGE - FULL INSET

- V0138-DBAC**
DARK BRUSHED ANTIQUÉ COPPER
- V0138-MB**
MATTE BLACK
- V0138-SN**
SATIN NICKEL
- V0138-AB**
ANTIQUÉ BRASS
- V0138-WI**
WROUGHT IRON

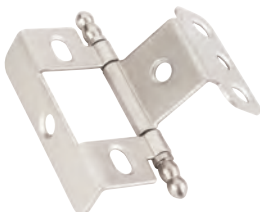

BALL TIP FULL WRAP AROUND HINGE - FULL INSET

- V0128-AB**
ANTIQUÉ BRASS
- V0128-DBAC**
DARK BRUSHED ANTIQUÉ COPPER
- V0128-MB**
MATTE BLACK
- V0128-SN**
SATIN NICKEL
- V0128-WI**
WROUGHT IRON



MINARET TIP PARTIAL WRAP AROUND HINGE - FULL INSET

- V0148-AB**
ANTIQUÉ BRASS
- V0148-DBAC**
DARK BRUSHED ANTIQUÉ COPPER
- V0148-MB**
MATTE BLACK
- V0148-SN**
SATIN NICKEL
- V0148-WI**
WROUGHT IRON

ITEM

V0128-AB

V0128-DBAC

V0128-MB

V0128-SN

V0138-AB

V0138-DBAC

V0138-MB

V0138-SN

V0148-AB

V0148-DBAC

V0148-MB

V0148-SN

V0128-WI

V0138-WI

V0148-WI

BIFOLD LOCKING HINGES



VBF10
2 1/2" H X 2 1/4" W
 ■ LOCKS OPEN OR CLOSED DOORS
 ■ HEAVY DUTY CONSTRUCTION

ITEM

VBF10

H HINGES



V15-BL
BLACK
1 1/2" X 3 1/2"
 ■ INCLUDES SCREWS



V16-AB
ANTIQUÉ BRASS
1 1/2" X 3 1/2"

ITEM

V149-AE

V15-BL

V16-AB

V19-AE

V25-AE

V25-BL

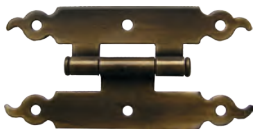

V19-AE
ANTIQUÉ ENGLISH
1 1/2" X 3 1/2"

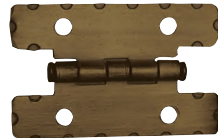

V25-AE
ANTIQUÉ ENGLISH
2 1/2" H



V25-BL
BLACK
2 1/2" H



V149-AE
ANTIQUÉ ENGLISH
1 1/2" X 1 1/2"
 ■ FINIAL TIP

HINGE I

SELF CLOSING SPRING



V11-AB
ANTIQUÉ BRASS
3/8" INSET



V30-AE
ANTIQUÉ ENGLISH
3/8" INSET



V73-BL
BLACK
3/8" INSET

ITEM

SOLD IN

V11-AB PAIRS

V30-AE PAIRS

V73-BL PAIRS

HINGE III

SELF CLOSING SPRING



V10
POLISHED BRASS
FLUSH



V32-AE
ANTIQUÉ ENGLISH
FLUSH



V73-A
BLACK
FLUSH

ITEM

SOLD IN

V10 PAIRS

V32-AE PAIRS

V73-A PAIRS

HINGE IV



V148-BL
BLACK



V148-SN
SATIN NICKEL



V148-WI
WROUGHT IRON

ITEM
V148-BL
V148-SN
V148-WI

SELF-CLOSING HINGES



V21-AB
ANTIQUE BRASS

- SEMI-CONCEALED
- 3/8" INSET WRAP AROUND



V22-AB
ANTIQUE BRASS
1/2" OVERLAY
■ WRAP AROUND HINGES
■ ADJUSTABLE MOUNTING HOLES

ITEM	SOLD IN
V21-AB	PAIRS
V22-AB	PAIRS

YOUNGDALE KNIFE HINGES



V120
ANTIQUE BRASS
#4 = 3/8" INSET



V120-BL
BLACK
#4 = 3/8" INSET



V120-RB
OIL RUBBED BRONZE
#4 = 3/8" INSET

ITEM	SOLD IN
V120	PAIRS
V120-RB	PAIRS
V120-BL	PAIRS
V120-NI	PAIRS
V120-W	PAIRS
V123	PAIRS
V125	PAIRS
V126	PAIRS



V120-NI
NICKEL
#4 = 3/8" INSET



V120-W
WHITE
#4 = 3/8" INSET



V123
ANTIQUE BRASS
#3 = 1/4" OVERLAY



V125
ANTIQUE BRASS
#5 = 5/16" OVERLAY



V126
ANTIQUE BRASS
#6 = 1/2" OVERLAY

FLUSH HINGE

- THREE-WAY ADJUSTABLE
- 90° ANGLE OF OPENING
- 35MM DIAMETER DRILL BIT NEEDED FOR INSTALLATION
- 12MM CUP DEPTH
- SCREWS INCLUDED
- SCREW ON WITH CHIP BOARD SCREWS 3 X 13MM



V170-AB
ANTIQUE BRASS

ITEM
V170-AB

SEWING MACHINE HINGES



V50-DAB
DARK ANTIQUE BRONZE
1 1/4" W X 3 1/8" L



V116-PB
POLISHED BRASS
1 3/16" W X 2 13/16" L



V116-AE
ANTIQUENGLISH
1 3/16" W X 2 13/16" L



V100-BZ
BRONZE
1 3/16" W X 2 9/16" L

ITEM
V50-DAB
V116-PB
V116-AE
V100-BZ

BUTLER TRAY HINGES

- LEAF SPRING LOCKS HINGE AT 90° AND 180°
- SCREWS INCLUDED
- SIZE FULLY OPENED: 1 1/2" HIGH X 2 7/8" WIDE



V2010
HEAVY EXTRUDED BRASS



V2010-BL
BLACK

ITEM	SOLD IN
V2010	PAIRS
V2010-BL	PAIRS

NO MORTISE HINGES



BH16-A
ANTIQUENGLISH
2" H
BH16-BL
BLACK
2" H



V20-DAB
DARK ANTIQUE BRONZE
LID HINGE FOR 3/4" WOOD



BH14-DAB
2" H LARGE LEAF 7/8" W
BH14-BL
2" H LARGE LEAF 7/8" W
BH15-DAB
2 1/2" H LARGE LEAF 1" W
BH15A-DAB
3" H LARGE LEAF 1 1/16" W
■ FINIAL TIP

ITEM
BH14-DAB
BH14-BL
BH15-DAB
BH15A-DAB
BH16-A
BH16-BL
V20-DAB

OVERLAY DOOR HINGE



V76-BL
BLACK

- HINGE FOR 270°
- WILL ALLOW CABINET DOORS TO FOLD AT SIDES

ITEM
V76-BL

BUTTERFLY HINGE



H110
BRASS PLATED STEEL
2" H X 2 1/4" L

ITEM
H110

PIE SAFE TINS

HERSHBERGER'S HARDWARE IS A DISTRIBUTOR FOR IRVIN'S TINS!

- HIGHEST QUALITY PIE SAFE TINS ON THE MARKET
- LACQUERED FINISH, NO PEEL OFF PLASTIC
- FRESH NEW DESIGNS
- SIZE 10" X 14"

ITEM
PST24-C
PST24-BT
PST25-C
PST25-BT
PST26-AT
PST26-BT
PST26-C
PST27-AT
PST27-C

H-SELECT



FEDERAL STAR
PST26-AT
ANTIQUE TIN



FEDERAL STAR
PST26-C
ANTIQUE COPPER



FEDERAL STAR
PST26-BT
BLACKENED TIN



3 STAR EMBOSSED
PST27-AT
ANTIQUE TIN



3 STAR EMBOSSED
PST27-C
ANTIQUE COPPER



WHEAT
PST24-BT
BLACKENED TIN



WHEAT
PST24-C
ANTIQUE COPPER



WHEAT
PST25-BT
BLACKENED TIN



WHEAT
PST25-C
ANTIQUE COPPER

SELF-ADHESIVE FELT

- GREAT FOR LINING GUN CABINETS, JEWELRY BOXES, ETC. FELT IS EASY-TO-USE
- JUST CUT TO SIZE, PEEL OFF BACK AND STICK IN PLACE!
- SOLD BY THE RUNNING FOOT (54" ROLL WIDTH)

ITEM	SOLD BY
AFBL-4	FOOT



AFBL-4
BLACK



AMERICAN DINER

AVAILABLE FINISHES

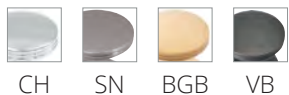

P2140-SN
Small Knob
1" Dia.



P2142-SN
Large Knob
1 3/8" Dia.

ITEM

P2140

P2141

P2142

P2143

P2144



P2143-SN
3" C/C



P2141-SN
96MM C/C



P2144-SN
3" & 96MM C/C

NOTE: P2144 is not available in VB Finish.

BRIDGES

AVAILABLE FINISHES

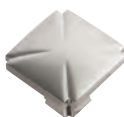

P3230-SN
1 5/32" SQ
1" PROJ

ITEM

P3230

P3231

P3232



P3231-SN
3" C/C, 3 5/8" L



P3232-SN
96MM C/C, 4 7/16" L

BELWITH

BUNGALOW

AVAILABLE FINISHES



P2153-OBH
3" & 96MM C/C

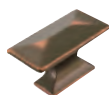

P2150-OBH
Small Knob
1 1/4" L



P2151-OBH
Medium Knob
1 3/4" L

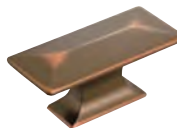

P2152-OBH
Large Knob
2 5/16" L

ITEM

P2150

P2151

P2152

P2153

CHARLESTON BLACKSMITH

AVAILABLE FINISHES



P1311-RI
Knob
1 1/2" Dia.



P1312-RI
Knob
1 1/4" Dia.

ITEM

PA1322

PA1323

PA1311

PA1312

PA1321



P1321-RI
3" C/C
3 3/4" L



PA1322-RI
3" C/C, 4 3/8" L



PA1323-RI
3" C/C, 4 1/2" L

CRAFTSMAN

AVAILABLE FINISHES



CH WOA OBH BI



P2174-WOA
96MM C/C



P2172-WOA
Square Knob
1 1/4" SQ



P2170-WOA
Round Knob
1 1/4" Dia.



P2171-WOA
3" C/C



P2173-WOA
96MM C/C

ITEM

P2170

P2171

P2172

P2173

P2174

CREST

AVAILABLE FINISHES



SN CH FUB



H076127-CH
Square Knob
1 1/4" Dia.



H076128-CH
Round Knob
1 1/4" Dia.



H076129-CH
3" C/C
3 1/2" L



H076130-CH
96MM C/C
4" L



H076131-CH
128MM C/C
5 9/16" L



H076132-CH
160MM C/C
6 13/16" L



H076133-CH
192MM C/C
8 1/16" L



H076134-CH
224MM C/C
9 5/16" L

ITEM

H076127

H076128

H076129

H076130

H076131

H076132

H076133

H076134

H076135

H076135-CH
12" C/C
12 1/2" L

EURO CONTEMPORARY

AVAILABLE FINISHES



SN OBH



P2164-OBH
4" C/C
7" L

P2165-OBH
128MM C/C
9" L



P2163-OBH
Square knob
1 1/2" SQ

ITEM

P2163

P2164

P2165

FORGE

AVAILABLE FINISHES



SN CH BGB CP VB BI

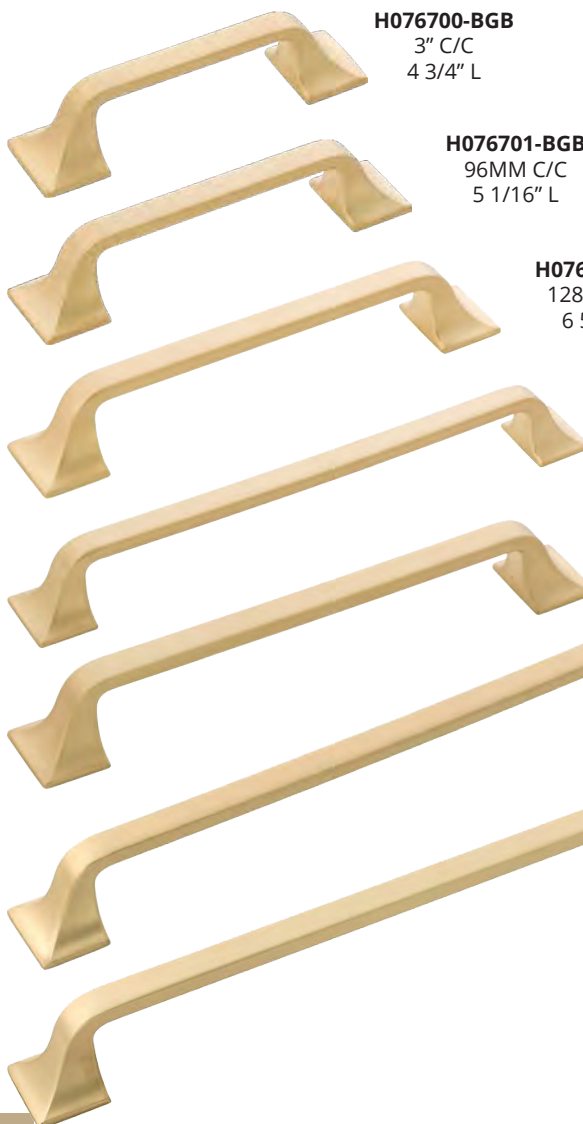

H076700-BGB
3" C/C
4 3/4" L

H076701-BGB
96MM C/C
5 1/16" L

H076702-BGB
128MM C/C
6 5/16" L

H076704-BGB
192MM C/C
7 9/16" L

H076703-BGB
160MM C/C
7 5/8" L

H076705-BGB
224MM C/C
10 1/8" L

H076706-BGB
12" C/C
13 3/8" L



H076698-BGB
Round Knob
1 3/8" Dia.



H076699-BGB
Square Knob
1 7/16" Dia.

ITEM

H076698

H076699

H076700

H076701

H076702

H076703

H076704

H076705

H076706

BELWITH

GREENWICH

AVAILABLE FINISHES



14 SS WOA 10B



P3370-SS
96MM C/C
4 1/4" L



P3371-SS
128MM C/C
6 3/8" L



P3041-SS
224MM C/C
10" L



P3374-SS
12" C/C
13 1/4" L



ITEM

P3041

P3370

P3371

P3372

P3374

P3375



P3372-SS
Knob
1 11/16" Dia.

P3375-SS
18" C/C
19 1/4" L

BELWITH

KNOBS

AVAILABLE FINISHES



SN MB



P2712-MB
Small Knob
1" Dia.



PA1218-MB
Large Knob
1 1/4" Dia.



PA1217-MB
Small Knob
1" Dia.

ITEM

P2712

PA1217

PA1218

NOTE: P2712 is only available in MB Finish.

LUNA

AVAILABLE FINISHES



SN MB VB



P3448-VB
3" C/C
4 1/8" L

ITEM

P3448

MANCHESTER

AVAILABLE FINISHES



P2014-RI
2 1/8" L X 1 1/2" W



P2023-RI
96MM C/C
4 1/8" L

ITEM

P2014

P2023

MANOR HOUSE

AVAILABLE FINISHES

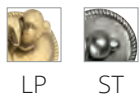

P329-ST
3" C/C



P8049-ST
3" C/C, 4" L



MOCK KEY
P321-ST
1" PROJ



BACKPLATE
P326-ST
5 1/2" L X 1" W

ITEM

P321

P326

P329

P8049

NOTE: P321, P326, and P329 are not available in DAC Finish.

BELWITH

METROPOLIS

AVAILABLE FINISHES



P2922-SN
96MM C/C



P2921-SN
2 9/16" C/C



PA0221-SN
96MM C/C, 4 3/4" L

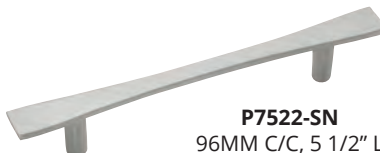

P7522-SN
96MM C/C, 5 1/2" L



P3221-SN
128MM C/C, 6 3/8" L



P7523-SN
Oblong Knob
1 5/8" L



PA0213-SN
Small Knob
1" Dia.

ITEM

P2921

P2922

P7522

P7523

PA0213

PA0221

NOTE: PA0221, P3221, P7522 and P7523 are only available in SN Finish.

MOUNTAIN LODGE

AVAILABLE FINISHES



P3062-WOA
Square Knob
1 1/4" SQ



P3063-WOA
Round Knob
1 1/4" Dia.



P3061-WOA
Round Knob
1 1/4" Dia.



P3060-WOA
3" C/C

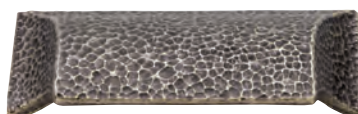

P3064-WOA
96MM C/C

ITEM

P3060

P3061

P3062

P3063

P3064

PIPELINE

AVAILABLE FINISHES

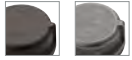

VB BNV



HH075028
1 1/4" Dia.



HH076013-BNV
3" C/C, 3 3/4" L



HH076011-BNV
96mm C/C, 4 1/2" L



HH076012-BNV
128mm C/C, 5 3/4" L



HH075010-BNV
160mm C/C, 7" L

ITEM

HH075010

HH075028

HH076011

HH076012

HH076013

RALEIGH

AVAILABLE FINISHES



PN SN WOA OBH



P3111-WOA
5" C/C, 5 3/4" L

ITEM

P3111

REFINED RUSTIC

AVAILABLE FINISHES

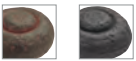

RI BL



P3002-BL
1 1/4" Dia.



P3003-BL
1 1/2" Dia.



P3001-BL
3" C/C, 4 3/4" L



P3000-BL
96MM C/C, 5 1/2" L



P3004-BL
3" & 96MM C/C, 5 1/2" L

ITEM

P3000

P3001

P3002

P3003

P3004

ROCHESTER

AVAILABLE FINISHES



PN SN OBH



P3112-SN
96 MM C/C, 4 1/4" L



P3114-SN
96 MM C/C, 4 1/8" L

ITEM

P3112

P3114

SOMERSET

AVAILABLE FINISHES



SN BNV DAC



74554-DAC
1 1/8" SQ

ITEM

74554

SKYLIGHT

AVAILABLE FINISHES

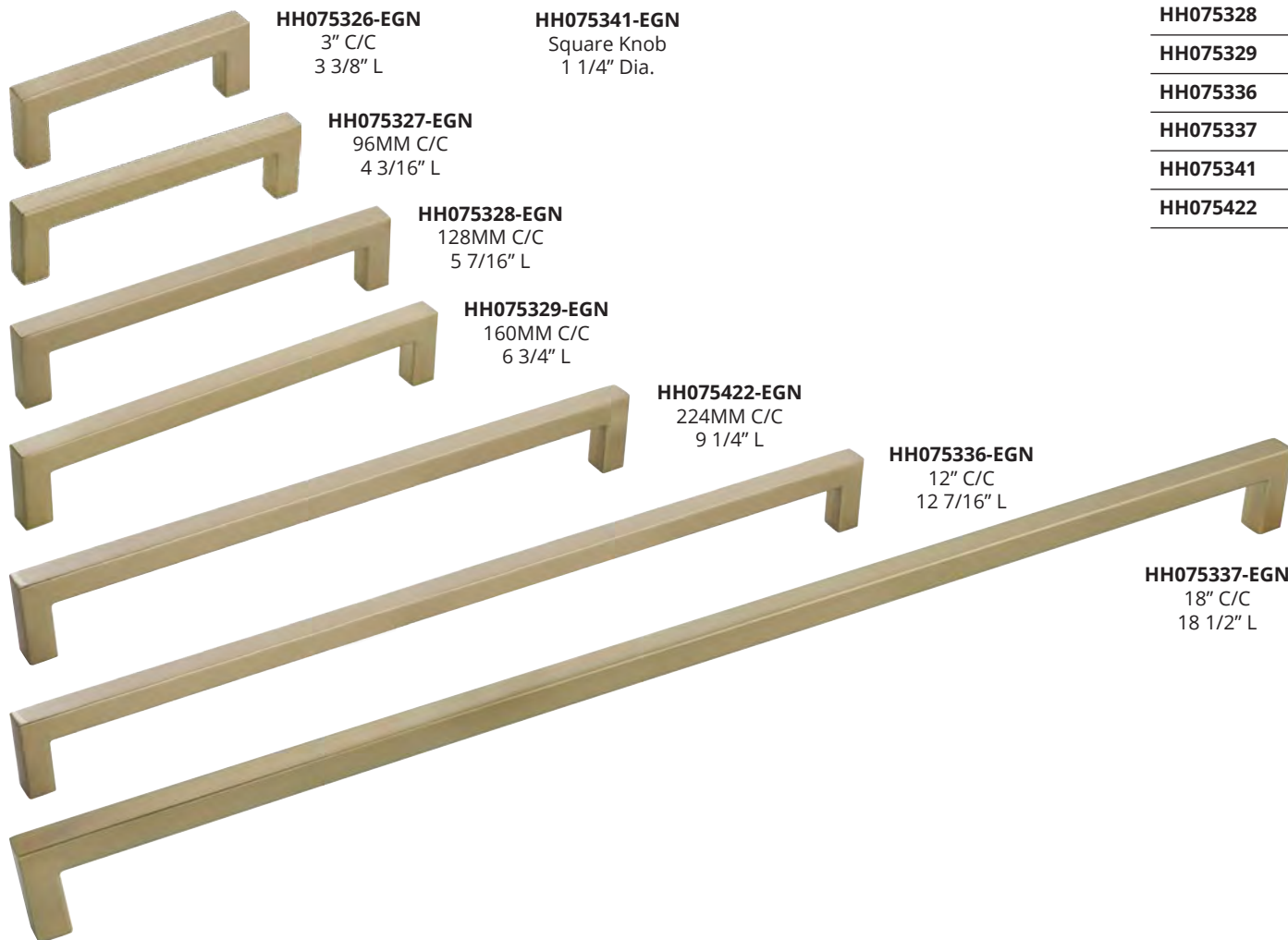

HH075326-EGN

3" C/C
3 3/8" L

HH075341-EGN

Square Knob
1 1/4" Dia.

HH075327-EGN

96MM C/C
4 3/16" L

HH075328-EGN

128MM C/C
5 7/16" L

HH075329-EGN

160MM C/C
6 3/4" L

HH075422-EGN

224MM C/C
9 1/4" L

HH075336-EGN

12" C/C
12 7/16" L

HH075337-EGN

18" C/C
18 1/2" L

ITEM
HH075326
HH075327
HH075328
HH075329
HH075336
HH075337
HH075341
HH075422

BELWITH

STUDIO

AVAILABLE FINISHES



P3010-OBH

3" C/C

P3014-OBH

Small Knob
1" SQ

P3011-OBH

96MM C/C

P3015-OBH

Large Knob
1 1/4" SQ

P3013-OBH

3" & 96MM C/C

NOTE: P3014 is only available in PN, SN, and OBH Finishes.

ITEM
P3010
P3011
P3013
P3014
P3015

TWIST

AVAILABLE FINISHES



H076015-CP
3" C/C
3 5/8" L



H076016-CP
96mm C/C
4 7/16" L



H076017-CP
128mm C/C
5 11/16" L



H076018-CP
160mm C/C
6 15/16" L



H076019-CP
192mm C/C
8 1/4" L



H076020-CP
224mm C/C
9 9/16" L



H076021-CP
12" C/C
12 11/16" L



H076014-CP
1 1/4" Dia.

ITEM
H076014
H076015
H076016
H076017
H076018
H076019
H076020
H076021

ZEPHYR

AVAILABLE FINISHES

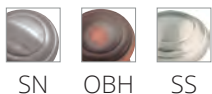

P2286-SN
Small Knob
1" Dia.



P2283-SN
Large Knob
1 1/4" Dia.



P2280-SN
3" C/C



P2281-SN
96MM C/C



P2282-SN
128MM C/C

ITEM
P2280
P2281
P2282
P2283
P2286

CRAFTSMAN

AVAILABLE FINISHES



CH WOA BI OBH

ITEM

P2175

P2175-BI
HOOK
1 3/8" C/C
5 1/16" L X 2" W



BUNGALOW

AVAILABLE FINISHES



SN WOA OBH 10B PN

ITEM

P2155

P2155-WOA
HOOK
1 1/2" C/C
5" L X 2" W



FORGE SIGNATURE HOOKS

AVAILABLE FINISHES



SN CH BGB BI

ITEM

S077190

S077190-BGB
HOOK
1 1/2" C/C
2 3/4" L X 2" W



PIPELINE SIGNATURE HOOKS

AVAILABLE FINISHES



BNV VB

ITEM

S077188

S077188-BNV
HOOK
1 1/2" C/C
2 1/2" L X 1 1/8" W



SKYLIGHT SIGNATURE HOOKS

AVAILABLE FINISHES



14 SS BGB VB

ITEM

S077192

S077192-14
HOOK
1" C/C
4 7/8" L X 1 1/22" W

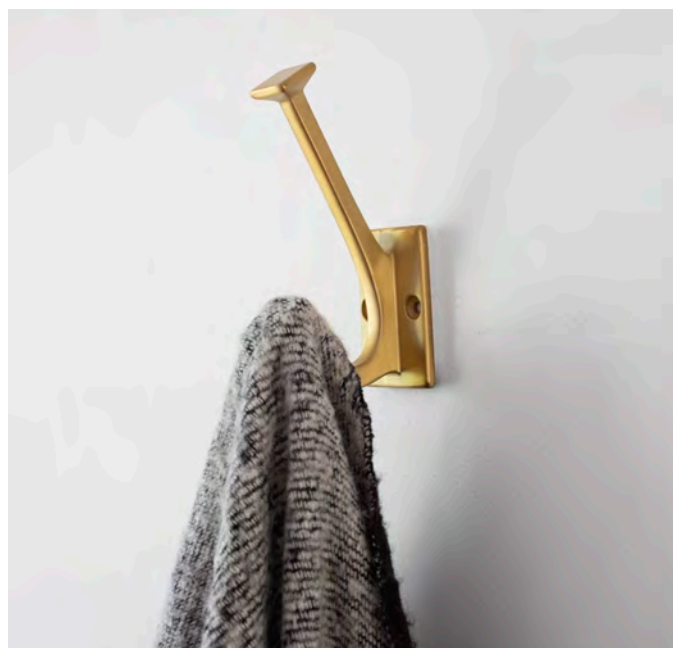

JEFFREY ALEXANDER®
by Hardware Resources

Aberdeen

AVAILABLE FINISHES

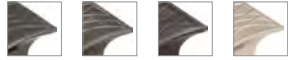

BNB BNBDL DBAC SN



535-BNB
Square Knob
1 1/4" Dia.



535L-BNB
Oblong Knob
1 1/2" Dia.



535-96-BNB
3 3/4" CC
5" Long



536-96-BNB
3 3/4" CC cup pull
5" Long



535-128-BNB
5" CC
6 1/4" Long



536-128-BNB
5" CC cup pull
6 1/4" Long



535-160-BNB
6 1/4" CC
5 5/8" Long

Item
535
535L
535-96
536-96
535-128
536-128
535-160

Alvar

AVAILABLE FINISHES

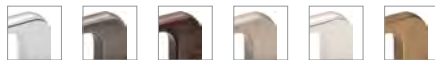

PC BNBDL DBAC SN NI SBZ



264-3-SBZ
3" CC
3 11/16" Long



264-96-SBZ
3 3/4" CC
5 7/16" Long



264-128-SBZ
5" CC
5 3/4" Long



264-160-SBZ
6 1/4" CC
7" Long



264-192-SBZ
7 9/16" CC
8 1/4" Long

Item
264-3
264-96
264-128
264-160
264-192

Amsden*

AVAILABLE FINISHES



DP DMAC DBAC SN NI

***DISCONTINUED**
Limited Stock Available!



613-DMAC
Small Knob
1 7/16" Dia.



613L-DMAC
Large Knob
1 5/8" Dia.

Item
613
613L
613-96
613-128
613-160



613-96-DMAC
3 3/4" CC
4 3/8" Long



613-128-DMAC
5" CC
5 5/8" Long



613-160-DMAC
6 1/4" CC
6 7/8" Long

Annadale

AVAILABLE FINISHES

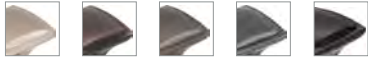

SN DBAC BNBDL DACM MB



435-DACM
Square knob
1 1/4" Dia.



435L-DACM
Oblong knob
1 1/2" Dia.



435-96-DACM
3 3/4" CC
5" Long



435-128-DACM
5" CC
6 1/4" Long



435-160-DACM
6 1/4" CC
7 5/8" Long



436-96-DACM
3 3/4" CC cup pull
5" Long



436-128-DACM
5" CC cup pull
6 1/4" Long

Item
435
435L
435-96
436-96
435-128
436-128
435-160

Anwick

AVAILABLE FINISHES



BNBDL DBAC NI SN



867-SN
Oblong Knob
1 3/8" Dia.



867L-SN
Square Knob
1 1/8" Dia.



867-3-SN
3" CC
4 5/16" Long



867-96-SN
3 3/4" CC
5 1/8" Long



867-128-SN
5" CC
6 3/8" Long



867-160-SN
6 1/4" CC
7 5/8" Long



867-228-SN
9" CC
10 5/16" Long



867-320-SN
12 5/8" CC
13 15/16" Long

Item
867
867L
867-3
867-96
867-128
867-160
867-228
867-320

JEFFREY ALEXANDER

Audrey

AVAILABLE FINISHES



MB BNBDL DBAC SBZ BG SN PC



278-96-SBZ
96MM CC
4 1/4" Long



278-128-SBZ
128MM CC
5 9/16" Long



278-160-SBZ
160MM CC
6 13/16" Long



278-192-SBZ
192MM CC
8 1/16" Long



278-224-SBZ
224MM CC
9 3/8" Long



278-12-SBZ
12" CC
12 5/8" Long



278-305-SBZ
305MM CC
12 9/16" Long



278-18-SBZ
18" CC
18 3/4" Long



278-SN
Square Knob
1 1/8" Dia.



278L-SBZ
Square Knob
1 3/8" Dia.

Item
278
278L
278-96
278-128
278-160
278-192
278-224
278-12
278-305
278-18

JEFFREY ALEXANDER

Belcastel 1

AVAILABLE FINISHES

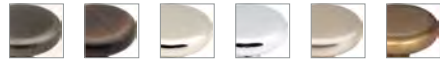

BNBDL DBAC NI PC SN SBZ

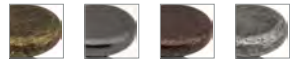

ABM-D DACM DMAC SIM-D



MO6303-BNBDL
Knob
1 3/8" Dia.

Item
MO6303
MO6373
MO6373-128
MO6373-160
MO6373-12
MO6373-18



MO6373-BNBDL
3 3/4" CC
4 5/8" Long



MO6373-128-BNBDL
5" CC
5 7/8" Long



MO6373-160-BNBDL
6 1/4" CC
7 1/8" Long



MO6373-12-BNBDL
12" CC appliance pull
13 1/4" Long



MO6373-18-BNBDL
18" CC appliance pull
19 1/4" Long

JEFFREY ALEXANDER

Bella

AVAILABLE FINISHES



ABSB BNBDL DBAC NI SN



818-ABSB
Round Knob
1 3/8" Dia.



818L-ABSB
T Knob
2 1/4" Dia.

Item

818

818L

818-96

818-128

818-160

818-12



818-96-ABSB
3 3/4" CC
4 3/8" Long



818-128-ABSB
5" CC
5 11/16" Long



818-160-ABSB
6 1/4" CC
6 15/16" Long



818-12-ABSB
12" CC appliance pull
13 1/8" Long

JEFFREY ALEXANDER

Bienville*

AVAILABLE FINISHES



ABSB BNBDL DBAC

***DISCONTINUED**
Limited Stock Available!



959-BNBDL
Knob
1 5/16" Dia.



959-96-BNBDL
3 3/4" CC
5 13/16" Long

Item

959

959-96

Bordeaux

AVAILABLE FINISHES

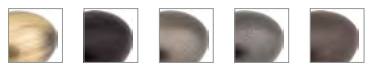

AB BLK BNBDL DACM DBAC



NI ORB PC SIM SN



3990-ORB
Egg Knob
1 3/16" Dia.



8236-ORB
3 3/4" CC
5" Long

Item

3990

8236

Boswell

AVAILABLE FINISHES



MB BNBDL DBAC PC SN



177-96
96MM CC
4 1/4" Long



177-128
128MM CC
5 9/16" Long



177-160
160MM CC
6 13/16" Long



177-192
192MM CC
8 1/16" Long



177-224
224MM CC
9 5/16" Long

Item
177-96
177-128
177-160
177-192
177-224



678-BG
Wheeler

678-96-BG
Wheeler

JEFFREY ALEXANDER

Bremen 1

AVAILABLE FINISHES



BNBDL DBAC NI PC SN SBZ



ABM-D ABSB DACM DMAC SIM



117-DACM
Knob
1 1/4" Dia.

Item
117
527
527-128
527-160
527-12



527-DACM
96MM CC
4 5/8" Long



527-128-DACM
5" CC
5 7/8" Long



527-160-DACM
6 1/4" CC
7 1/8" Long



527-12-DACM
12" CC appliance pull
13 1/16" Long

JEFFREY ALEXANDER

578-128-MB
Spencer



Bremen 2

AVAILABLE FINISHES



ABSB DACM DBAC DMAC NI SN



537-NI
3 3/4" CC
4 3/16" Long



537-128-NI
5" CC
5 7/16" Long



537-160-NI
6 1/4" CC
6 9/16" Long



537-12-NI
12" CC appliance
pull
12 11/16" Long



127-NI
Knob (barrel)
1 3/16" Dia.



137-NI
Knob (stacked)
1 1/4" Dia.

Item
127
137
537
537-128
537-160
537-12

Cairo

AVAILABLE FINISHES



PC BNBDL DBAC SN



595-SN
Knob
1 1/4" Dia.



595-96-SN
3 3/4" CC
4 13/16" Long



595-128-SN
5" CC
6 1/16" Long

Item
595
595-96
595-128

Callie

AVAILABLE FINISHES



BNBDL DBAC NI PC SN



839-3-PC
3" CC
4 3/16" Long



839-96-PC
3 3/4" CC
4 15/16" Long



839-128-PC
5" CC
6 1/4" Long



839-160-PC
60 1/4" CC
7 1/2" Long

Item
839-3
839-96
839-128
839-160

JEFFREY ALEXANDER

Carmen – New!

AVAILABLE FINISHES



775-96-SBZ
96MM CC
4 3/4" Long

775-128-SBZ
128MM CC
6" Long

737-160-BNBDL
160" CC
7 1/4" Long

775-SBZ
Knob
1 1/16" Dia.

775L-SBZ
"T" Knob
2" Long

Item
775
775L
775-96
775-128
775-160

Chesapeake

AVAILABLE FINISHES



915-BNBDL
Knob
1 5/16" Dia.

Z110-BNBDL
Knob
1 3/16" Dia.

737-96-BNBDL
3 3/4" CC
4 1/4" Long

737-128-BNBDL
5" CC
5 1/2" Long

737-160-BNBDL
6 1/4" CC
6 3/4" Long

737-12-BNBDL
12" CC appliance pull
12 15/16" Long

Item
915
Z110
737-96
737-128
737-160
737-12

NOTE: BNDL Finish is only available on Z110.

Cordova

AVAILABLE FINISHES



ABSB BNDL DBAC SN



0251-SN
Knob
1 3/8" Dia.



Z110-SN
Knob
1 3/16" Dia.



Z111-SN
Knob
1 1/4" Dia.

Item
0251
Z110
Z111
Z281
Z280
Z281-128
Z281-160
Z281-12
Z281-18

NOTE: 0251 is also available in BNDL Finish. Z110 is also available in BNBDL, DACM or SIN Finishes. 0251 is not available in BNDL.



Z281-SN
3" CC
3 3/8" Long



Z280-SN
3 3/4" CC
4 3/16" Long



Z281-128-SN
5" CC
5 7/16" Long



Z281-160-SN
6 1/4" CC
6 11/16" Long



Z281-12-SN
12" CC appliance pull
12 3/4" Long



Z281-18-SN
18" CC appliance pull
18 3/4" Long

JEFFREY ALEXANDER

Delgado

AVAILABLE FINISHES



BNBDL ABSB DBAC NI SN



519-96-NI
3 3/4" CC
4 1/4" Long



519-128-NI
5" CC
5 9/16" Long



519-160-NI
6 1/4" CC
6 13/16" Long

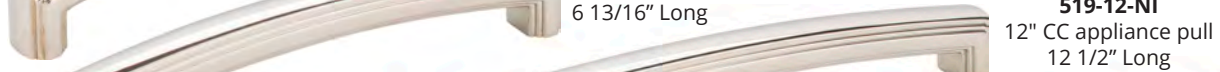

519-12-NI
12" CC appliance pull
12 1/2" Long



519-18-NI
18" CC appliance pull
18 1/2" Long



519-NI
Knob
1 9/16" Dia.

Item
519
519-96
519-128
519-160
519-12
519-18

Delmar

AVAILABLE FINISHES



SN DBAC BNBDL DACM DP



585-96-DP
3 3/4" CC
4 1/2" Long



585-DP
Small knob
1" Dia.



585L-DP
Large knob
1 1/4" Dia.



585-128-DP
5" CC
5 13/16" Long



585-160-DP
6 1/4" CC
7 1/16" Long



585-12-DP
12" appliance pull
13 1/4" Long

Item
585
585L
585-96
585-128
585-160
585-12

Dominique

AVAILABLE FINISHES



845-BNBDL
Knob
1 1/8" Dia.



845T -BNBDL
Knob
2" Dia.



845TL -BNBDL
Knob
2 1/4" Dia.



845-96-BNBDL
3 3/4" CC
5 3/4" Long



845-128 -BNBDL
5" CC
7 1/16" Long



845-160 -BNBDL
6 1/4" CC
8 5/16" Long



845-192 -BNBDL
7 1/2" CC
9 9/16" Long



845-305 -BNBDL
12" CC
14" Long



845-12 -BNBDL
12" CC
15" Long



845-18 -BNBDL
18" CC
21" Long

Item
845
845T
845TL
845-96
845-128
845-160
845-192
845-305
845-12
845-18

Durham

AVAILABLE FINISHES



3980-DBAC
Knob
1 1/4" Dia.

Item
3980
Z290-3
Z290-96
Z290-128
Z290-160
Z290-12



Z290-3-DBAC
3" CC
3 3/8" Long



Z290-96-DBAC
3 3/4" CC
4 1/4" Long



Z290-128-DBAC
5" CC
5 1/2" Long



Z290-160-DBAC
6 1/4" CC
6 3/4" Long



Z290-12-DBAC
12" CC
13" Long

Duval*

AVAILABLE FINISHES



***DISCONTINUED**
Limited Stock Available!



343-BNBDL
Knob
1 1/4" Dia.

Item
343
343-96
343-128
343-160
343-12



343-96-BNBDL
3 3/4" CC
4 1/2" Long



343-128-BNBDL
5" CC
5 13/16" Long



343-160-BNBDL
6 1/4" CC
7 1/16" Long



343-12-BNBDL
12" CC appliance pull
13 1/8" Long

Elara

AVAILABLE FINISHES



484-32-SBZ
32MM CC
2 1/16" Long



484-396-SBZ
3" or 96MM CC
4 9/16" Long



484-128160-SBZ
128MM or 160MM CC
7 1/8" Long



484-192224-SBZ
192MM or 224MM CC
9 5/8" Long



484-305-SBZ
305MM CC
12 13/16" Long



484-SBZ
Knob
1 1/4" Dia.

Item
484
484-32
484-396
484-128160
484-192224
484-305

Ella

AVAILABLE FINISHES



165-96-BNBDL
3 3/4" CC
4 1/2" Long



165-BNBDL
Knob
1 1/4" Dia.



165-128-BNBDL
5" CC
5 13/16" Long



165-160-BNBDL
6 1/4" CC
7 1/16" Long



165-12-BNBDL
12" CC
13" Long

Item
165
165-96
165-128
165-160
165-12

Glenmore

AVAILABLE FINISHES



ABSB BNMDL DACM DBAC



618-BNMDL
Small Knob
2 5/8" Dia.



618L-BNMDL
Large Knob
2 15/16" Dia.



718-BNMDL
5" CC
5 3/4" Long



718-128-BNMDL
5" CC bail pull
5 15/16" Long

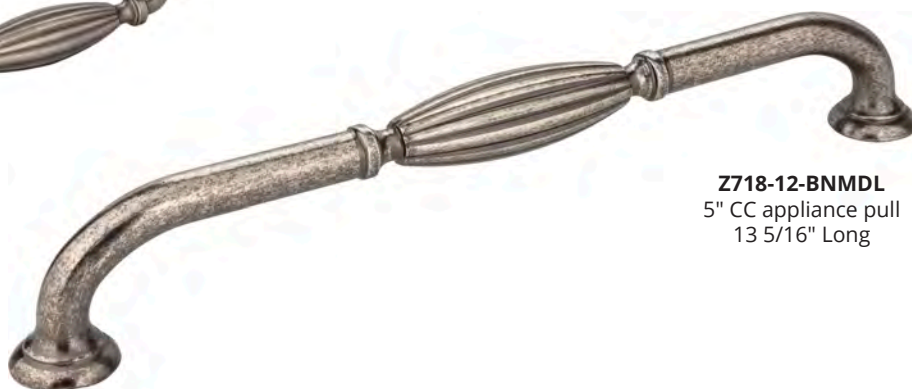

Z718-12-BNMDL
5" CC appliance pull
13 5/16" Long

Item
618
618L
718
718-128
Z718-12

JEFFREY ALEXANDER

Harlow



G110-DBAC
Small egg
1 1/4" Dia.



G120-PC
Small button
1 7/16" Dia.



G130-DBAC
Small sphere
1 1/16" Dia.



G110L-BNBDL
Large egg
1 5/8" Dia.



G120L-SN
Large button
1 3/4" Dia.



G130L-BNBDL
Large sphere
1 3/8" Dia.



G140-BNBDL
Small square
1" Dia.



G140L-SN
Large square
1 3/8" Dia.



G150-DBAC
Small faceted
1" Dia.



G150L-PC
Large faceted
1 1/4" Dia.

Item
G110
G110L
G120
G120L
G130
G130L
G140
G140L
G150
G150L

Hayworth

AVAILABLE FINISHES



NI PC SN



885-PC
Knob
1 1/8" Dia.



885L-PC
T Knob
2" Dia.



885-96-PC
3 3/4" CC
4 3/4" Long



885-128-PC
5" CC
6" Long



885-160-PC
6 1/4" CC
7 1/4" Long



885-192-PC
7 9/16" CC
8 1/2" Long



885-224-PC
8 13/16" CC
9 3/4" Long



885-305-PC
12" CC appliance pull
4 3/4" Long

Item
885
885L
885-96
885-128
885-160
885-192
885-224
885-305

JEFFREY ALEXANDER



478-DBAC
Larkin

Hudson

AVAILABLE FINISHES

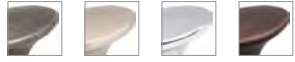

BNBDL SN PC DBAC



650-96-DBAC
3 3/4" CC
4 3/8" Long



650-128-DBAC
5" CC
5 5/8" Long



650-160-DBAC
6 1/4" CC
6 15/16" Long



650-12-DBAC
12" CC appliance pull
13" Long



650-DBAC
Knob
1 7/8" Dia.

Item
650
650-96
650-128
650-160
650-12

Katharine

AVAILABLE FINISHES

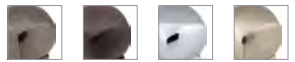

BNBDL DBAC PC SN



188-SN
Small Knob
7/8" Dia.



188L-SN
Large Knob
1" Dia.



188-96-SN
3 3/4" CC
4 3/8" Long



188-128-SN
5" CC
5 11/16" Long



188-160-SN
6 1/4" CC
6 15/16" Long

Item
188
188L
188-96
188-128
188-160

Key Grande

AVAILABLE FINISHES



MB MBBG BG MBSN SN



596-SN
3 3/4" CC
5 3/8" Long



5128-SN
5" CC
6 5/8" Long



5192-SN
7 9/16" CC
9 1/8" Long



5224-SN
8 13/16" CC
10 3/8" Long



5319-SN
12 5/8" CC
14 1/8" Long



5480-SN
18 7/8" CC
20 1/2" Long



5673-SN
26 1/2" CC
28 1/16" Long



5900-SN
35 7/16" CC
37" Long

Item
596
5128
5192
5224
5319
5480
5673
5900

JEFFREY ALEXANDER

Key West & Key Largo

AVAILABLE FINISHES



ORB SN MB BG SBZ

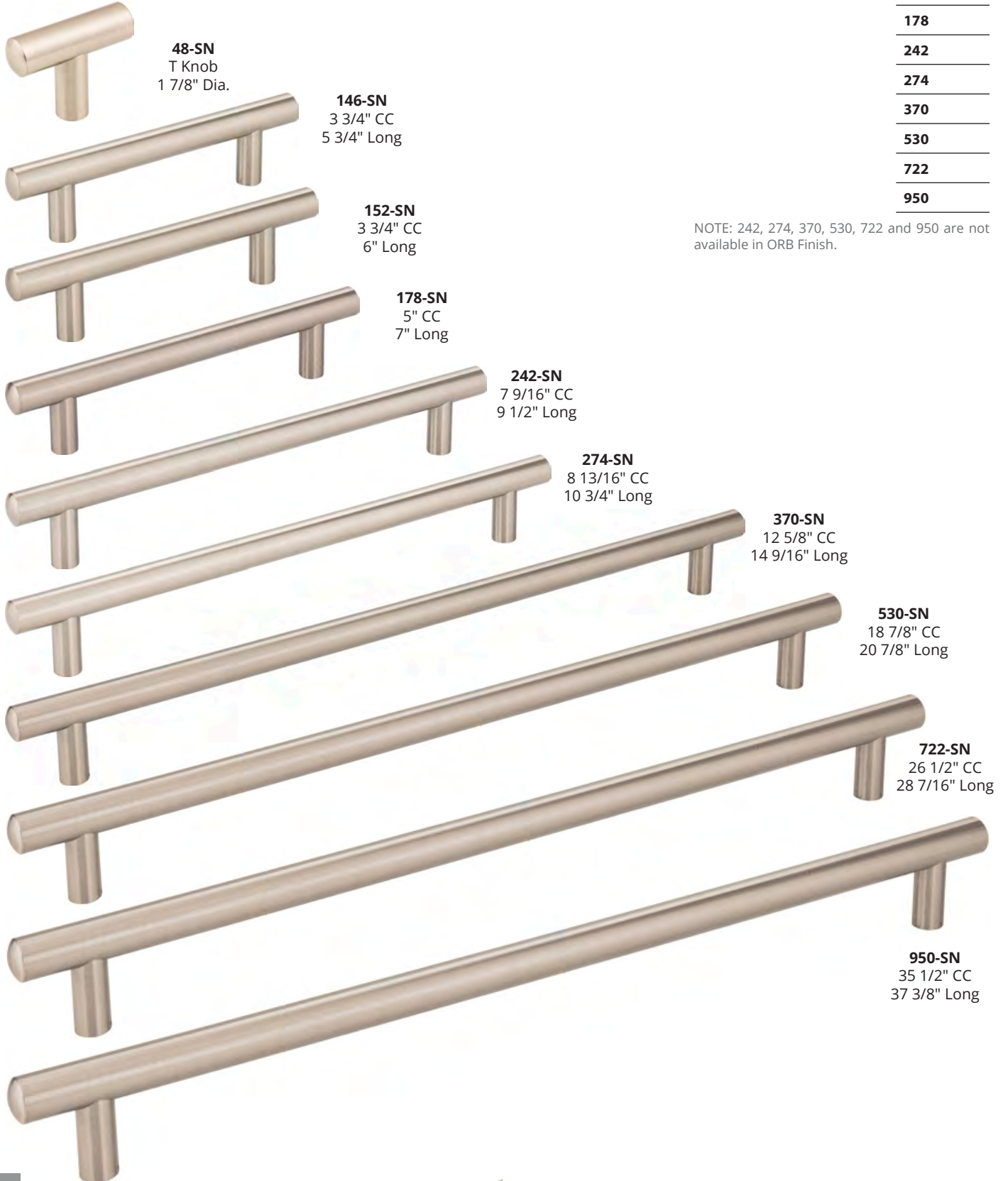

48-SN
T Knob
1 7/8" Dia.

146-SN
3 3/4" CC
5 3/4" Long

152-SN
3 3/4" CC
6" Long

178-SN
5" CC
7" Long

242-SN
7 9/16" CC
9 1/2" Long

274-SN
8 13/16" CC
10 3/4" Long

370-SN
12 5/8" CC
14 9/16" Long

530-SN
18 7/8" CC
20 7/8" Long

722-SN
26 1/2" CC
28 7/16" Long

950-SN
35 1/2" CC
37 3/8" Long

NOTE: 242, 274, 370, 530, 722 and 950 are not available in ORB Finish.

Item

48

146

152

178

242

274

370

530

722

950

Lafayette

AVAILABLE FINISHES



ABSB BNBDL DBAC SN



218-DBAC
Fleur-de-lis Knob
1 3/8" Dia.



317-DBAC
Circles Knob
1 3/8" Dia.



417-DBAC
Baroque Knob
1 3/8" Dia.

Item
218
317
417
317-96
317-128
317-160
317-12



317-96-DBAC
3 3/4" CC
4 3/8" Long



317-128-DBAC
5" CC
5 5/8" Long



317-160-DBAC
6 1/4" CC
6 7/8" Long



317-12-DBAC
12" CC appliance pull
12 15/16" Long



445-SBZ
Marie

JEFFREY ALEXANDER

Larkin 1 & 2 – New!

AVAILABLE FINISHES



Item
478T
478-96
478-128
478-160
478-192
478-305
478-12
478-18



478-96-MBSN
96MM CC
6 1/8" Long



478-128-MBSN
128MM CC
7 3/8" Long



478-160-MBSN
160MM CC
8 11/16" Long



478-192-MBSN
192MM CC
9 15/16" Long



478-305-MBSN
305MM CC
14 3/8" Long



478T-MBSN
"T" Knob
2 3/8" Long



478-12-MBSN
12" CC appliance pull
14 3/8" Long



478-18-MBSN
18" CC appliance pull
20 3/8" Long

JEFFREY ALEXANDER

Lenoir

AVAILABLE FINISHES



Item
Z117
8237



17-ABSB
Knob
1/4" Dia.



8237-ABSB
3 3/4" CC
5" Long

Lexa

AVAILABLE FINISHES



BN BNBDL DBAC PC SN



259-BN
Knob
2" Dia.



259-96-BN
3 3/4" CC
4 3/16" Long



259-128-BN
5" CC
5 7/16" Long



259-160-BN
6 1/4" CC
6 11/16" Long



259-192-BN
7 9/16" CC
8" Long

Item
259
259-96
259-128
259-160
259-192

Leyton

AVAILABLE FINISHES



BNBDL DBAC SN PC NI SBZ



286-96-SBZ
3 3/4" CC
5 1/8" Long



286-128-SBZ
5" CC
6 3/8" Long



286-160-SBZ
6 1/4" CC
7 11/16" Long



286-192-SBZ
7 9/16" CC
8 15/16" Long



286-224-SBZ
8 13/16" CC
10 3/16" Long

Item
286-96
286-128
286-160
286-192
286-224

JEFFREY ALEXANDER

Lille

AVAILABLE FINISHES



ABSB BNBDL DACM DBAC SN



415S-DACM
Small Knob
1 1/4" Dia.



415-DACM
Large Knob
1 3/8" Dia.



415-96-DACM
3 3/4" CC
4 3/8" Long



415-96V-DACM
3 3/4" CC asymmetrical
4 3/4" Long



415-128-DACM
5" CC
5 5/8" Long



415-160-DACM
6 1/4" CC
6 7/8" Long



415-12-DACM
12" CC appliance pull
12 7/8" Long

Item
415S
415
415-96
415-96V
415-128
415-160
415-12

JEFFREY ALEXANDER

Lyon

AVAILABLE FINISHES

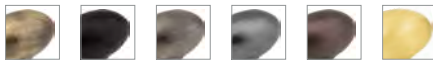

AB BLK BNBDL DACM DBAC BG



NI ORB PC SIM SN SBZ



3991-PC
Egg Knob
1 9/16" Dia.



8233-PC
3" CC
4 15/16" Long

Item
3991
8233

Marie – New!

AVAILABLE FINISHES

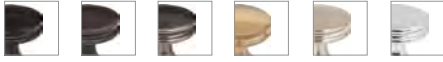

MB DBAC BNBDL SBZ SN PC



445-BNBDL
Knob
1 1/4" Dia.

Item
445
445-96
445-128
445-160
445-192
445-224
445-305
445-12
445-18



445-96-BNBDL
96MM CC
4 3/8" Long



445-128-BNBDL
128MM CC
5 5/8" Long



445-160-BNBDL
160MM CC
6 7/8" Long



445-192-BNBDL
192MM CC
8 3/16" Long



445-224-BNBDL
224MM CC
9 7/16" Long



445-305-BNBDL
305MM CC
12 11/16" Long

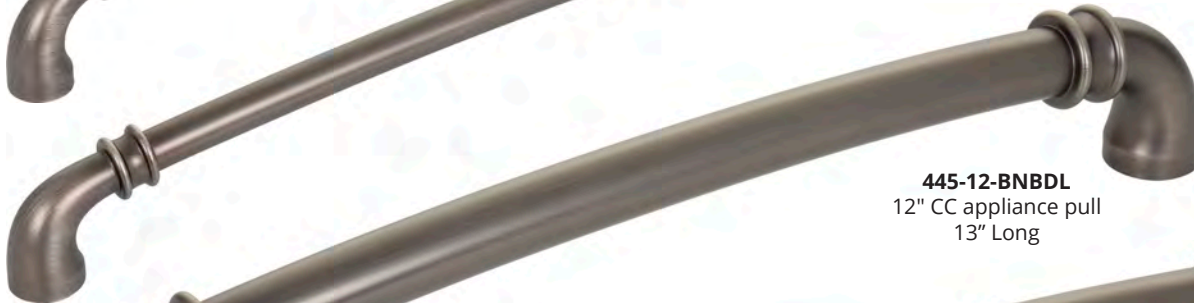

445-12-BNBDL
12" CC appliance pull
13" Long



445-18-BNBDL
18" CC appliance pull
19" Long

JEFFREY ALEXANDER

Marlo

AVAILABLE FINISHES



NI BNBDL DBAC PC SN



972S-SN
Small knob
7/8" Dia.



972-SN
Medium knob
1 1/8" Dia.



972L-SN
Large knob
1 1/4" Dia.



972-96-SN
3 3/4" CC
4 1/2" Long



972-128-SN
5" CC
5 13/16" Long



972-160-SN
6 1/4" CC
7 1/16" Long



972-224-SN
8 13/16" CC
9 3/4" Long



972-305-SN
12" CC
12 3/4" Long



972-12-SN
12" CC appliance pull
13" Long

Item
972S
972
972L
972-96
972-128
972-160
972-224
972-305
972-12

JEFFREY ALEXANDER

Maybeck*

AVAILABLE FINISHES



BN BNBDL DBAC PC SN

***DISCONTINUED**
Limited Stock Available!



225-DBAC
Knob
1 11/16" Dia.



225-96-DBAC
3 3/4" CC
5 1/4" Long



225-128-DBAC
5" CC
6 3/8" Long



225-160-DBAC
6 1/4" CC
7 7/16" Long

Item
225
225-96
225-128
225-160

Merrick

AVAILABLE FINISHES



PC BNBDL DBAC SN MB SBZ



549-96-SN
3 3/4" CC
4 3/16" Long



549-128-SN
5" CC
5 1/2" Long



549-160-SN
6 1/4" CC
6 3/4" Long



549-192-SN
7 9/16" CC
8" Long



549-320-SN
12 5/8" CC
13 1/16" Long

Item
549-96
549-128
549-160
549-192
549-320

JEFFREY ALEXANDER

Milan 1

AVAILABLE FINISHES



1091-SN
Knob
1 3/16" Dia.



1092-SN
3 3/4" CC
4 1/4" Long



1092-128-SN
5" CC
5 9/16" Long



1092-160-SN
6 1/4" CC
6 13/16" Long



1092-12-SN
12" CC
12 13/16" Long

Item
1091
1092
1092-128
1092-160
1092-12

Milan 2*

AVAILABLE FINISHES



***DISCONTINUED**
Limited Stock Available!



1093-AEM
Knob
1 3/16" Dia.



1094-AEM
3 3/4" CC
4 1/4" Long



1094-128-AEM
5" CC
5 9/16" Long



1094-160-AEM
6 1/4" CC
6 13/16" Long



1094-12-AEM
12" CC appliance pull
12 13/16" Long

Item
1093
1094
1094-128
1094-160
1094-12

Mirada

AVAILABLE FINISHES

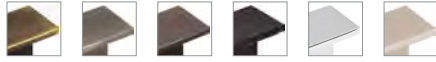

ABSB BNBDL DBAC MB PC SN



81021-PC
5/8" CC Knob
1 9/16" Dia.

Item
81021
80152-96
80152-128
80152-160



80152-96-PC
3 3/4" CC
5 9/16" Long



80152-128-PC
5" CC
6 13/16" Long



80152-160-PC
6 1/4" CC
8 1/16" Long

Montclair*

AVAILABLE FINISHES



SN

***DISCONTINUED**
Limited Stock Available!



935-SN
Knob
2" Dia.

Item
935
935-96
935-128
935-160
935-12



935-96-SN
3 3/4" CC
5 5/8" Long



935-128-SN
5" CC
7 1/2" Long



935-160-SN
6 1/4" CC
8 3/4" Long



935-12-SN
12" CC appliance pull
16" Long

JEFFREY ALEXANDER

Philip

AVAILABLE FINISHES



767-SBZ
Knob
1 1/4" Dia.



767-96-SBZ
3 3/4" CC
5" Long



767-128-SBZ
5" CC
6 5/16" Long



767-160-SBZ
6 1/4" CC
7 9/16" Long

Item
767
767-96
767-128
767-160

Prestige*

AVAILABLE FINISHES



918-DP
Knob
1 3/8" Dia.



918L-DP
Knob
2 1/4" Dia.



918-96-DP
3 3/4" CC
4 3/8" Long



918-128-DP
5" CC
5 11/16" Long



918-160-DP
6 1/4" CC
6 15/16" Long



918-12-DP
12" CC appliance pull
13 1/8" Long

***DISCONTINUED**
Limited Stock Available!

Item
918
918L
918-96
918-128
918-160
918-12

JEFFREY ALEXANDER®

by Hardware Resources

Rae

AVAILABLE FINISHES



667-3-NI
3" CC
3 7/16" Long

667-96-NI
3 3/4" CC
4 3/16" Long

667-128-NI
5" CC
5 1/2" Long

667-160-NI
6 1/4" CC
6 3/4" Long

667-224-NI
8 13/16" CC
9 1/4" Long

667-305-NI
12" CC
12 9/16" Long

667-12-NI
12" CC appliance pull
12 13/16" Long

667-18-NI
18" CC appliance pull
18 13/16" Long



667S-NI
Small Knob
1 1/16" Dia.



667-NI
Knob
1 1/4" Dia.



667L-NI
Large Knob
1 3/8" Dia.

Item
667S
667
667L
667-3
667-96
667-128
667-160
667-224
667-305
667-12
667-18

Regan

AVAILABLE FINISHES



847-96-BNBDL
3 3/4" CC
5 9/16" Long

847-128-BNBDL
5" CC
6 13/16" Long

847-160-BNBDL
6 1/4" CC
8 1/16" Long

Item
847-96
847-128
847-160

Renzo

AVAILABLE FINISHES



141-96-BG
3 3/4" CC
4 5/8" Long



141-128-BG
5 1/16" CC
5 7/8" Long



141-160-BG
6 5/16" CC
7 1/8" Long



141-192-BG
7 9/16" CC
8 3/8" Long



141-305-BG
12" CC
12 7/8" Long



141-BG
Square Knob
1 1/4" Dia.



141L-BG
Square Knob
1 3/4" Dia.

Item
141
141L
141-96
141-128
141-160
141-192
141-305

Rhodes

AVAILABLE FINISHES



Z260-3-DACM
3" CC
3 3/4" Long



Z261-96-DACM
3 3/4" CC
4 1/2" Long



B812-96R-DACM
3 3/4" CC
6" Long



Z261-128-DACM
5" CC
5 13/16" Long



Z260-12-DACM
12" CC appliance pull
13 1/4" Long



S6060-DACM
Knob & backplate
1 1/4" Dia.

Item
S6060
Z260-3
Z261-96
B812-96R
Z261-128
Z260-12

Richard – New!

AVAILABLE FINISHES



MB BNBDL DBAC SBZ BG SN PC



171-DBAC
Knob
1 1/4" Dia.



171L-DBAC
Knob
1 3/4" Dia.

Item
171
171L
171-96
171-128
171-160
171-192
171-305



171-96-DBAC
96MM CC
4 3/8" Long



171-128-DBAC
128MM CC
5 5/8" Long



171-160-DBAC
160MM CC
6 7/8" Long



171-192-DBAC
192MM CC
8 1/8" Long



171-305-DBAC
305MM CC
12 5/8" Long



171-12-DBAC
12" CC appliance pull
12 13/16" Long



171-18-DBAC
18" CC appliance pull
18 13/16" Long

JEFFREY ALEXANDER

Roman

AVAILABLE FINISHES

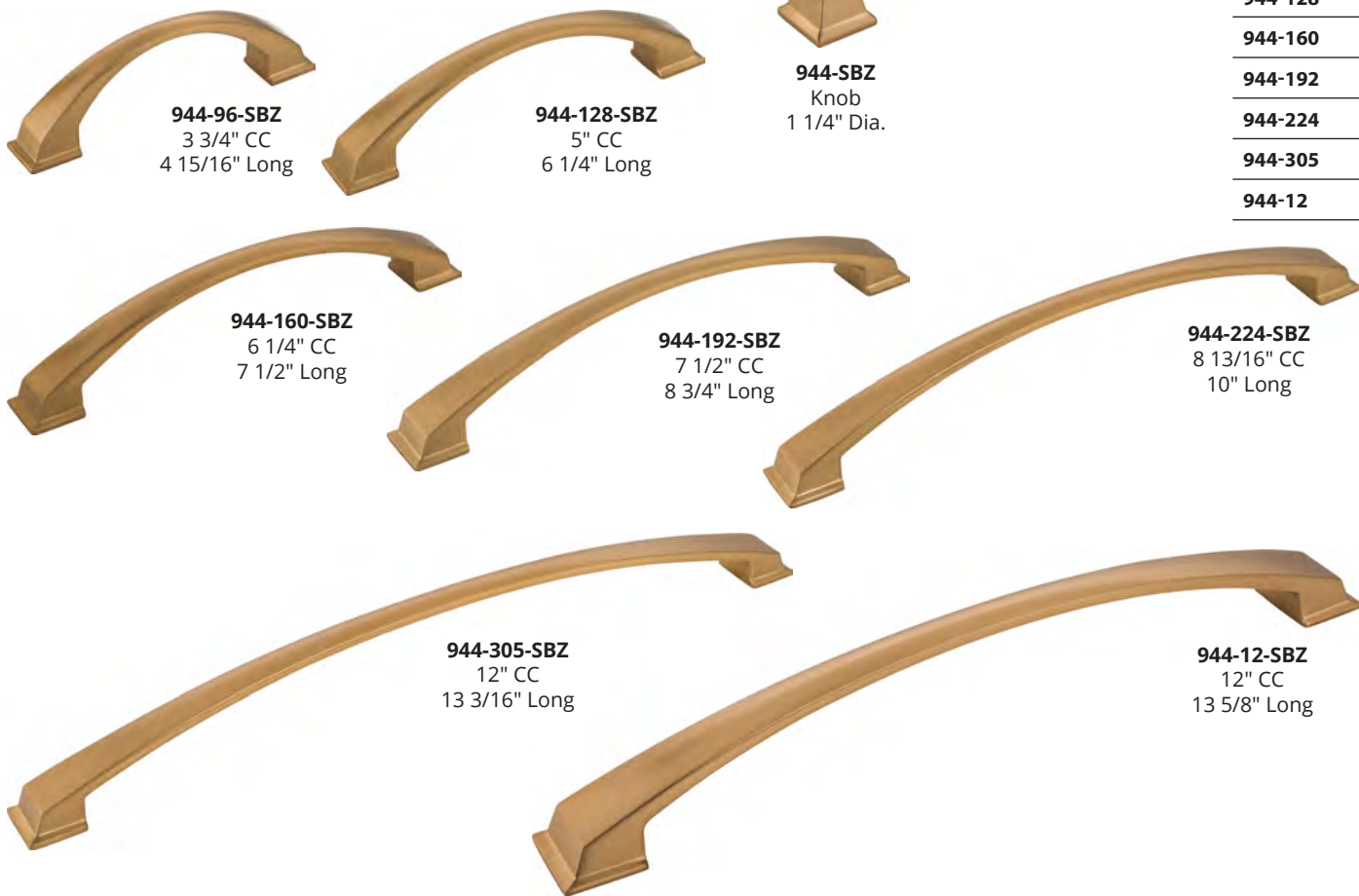

944-96-SBZ
3 3/4" CC
4 15/16" Long

944-128-SBZ
5" CC
6 1/4" Long

944-SBZ
Knob
1 1/4" Dia.

944-160-SBZ
6 1/4" CC
7 1/2" Long

944-192-SBZ
7 1/2" CC
8 3/4" Long

944-224-SBZ
8 13/16" CC
10" Long

944-305-SBZ
12" CC
13 3/16" Long

944-12-SBZ
12" CC
13 5/8" Long

Item
944
944-96
944-128
944-160
944-192
944-224
944-305
944-12

Royce

AVAILABLE FINISHES



431-PC
Knob
1 3/16" Dia.

595-PC
Knob
1 1/4" Dia.

798-96-PC
3 3/4" CC
5 1/2" Long

798-128-PC
5" CC
6 3/4" Long

798-160-PC
6 3/4" CC
8 1/2" Long

Item
431
595
798-96
798-128
798-160

Solana*

AVAILABLE FINISHES

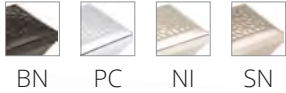

BN PC NI SN



457-96-BN
3 3/4" CC
6" Long

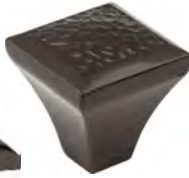

457-BN
Knob
1 1/4" Dia.



457L-BN
Knob
2" Dia.

***DISCONTINUED**
Limited Stock Available!

Item
457
457L
457-96

Sonoma

AVAILABLE FINISHES



BNBDL DBAC MB PC SN



4128-MB
5" CC
6 5/16" Long



4160-MB
6 1/4" CC
8" Long



4192-MB
7 9/16" CC
9 5/8" Long



4288-MB
11 3/8" CC
14 7/16" Long



431-MB
Knob
1 3/16" Dia.

Item
431
4128
4160
4192
4288

Spencer – New!

AVAILABLE FINISHES



MB SBZ BG SN PC



578T-SBZ
"T" Knob
2 3/8" Long



578-96-SBZ
96MM CC
6 1/8" Long

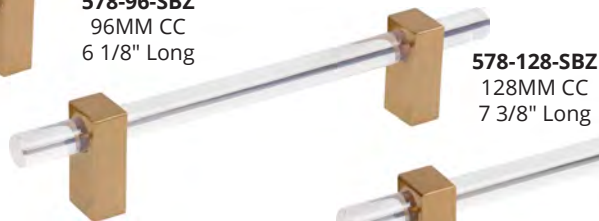

578-128-SBZ
128MM CC
7 3/8" Long



578-160-SBZ
160MM CC
8 11/16" Long

Item
578T
578-96
578-128
578-160

Sullivan

AVAILABLE FINISHES



752-96-DBAC
96MM CC
4 1/2" Long

752-128-DBAC
128MM CC
5 13/16" Long

752-160-DBAC
160MM CC
7 1/16" Long

752-192-DBAC
192MM CC
8 15/16" Long

752-224-DBAC
224MM CC
9 9/16" Long



752-19-DBAC
19MM CC
1 1/4" Dia.

Item
752-19
752-96
752-128
752-160
752-192
752-224

Sutton

AVAILABLE FINISHES

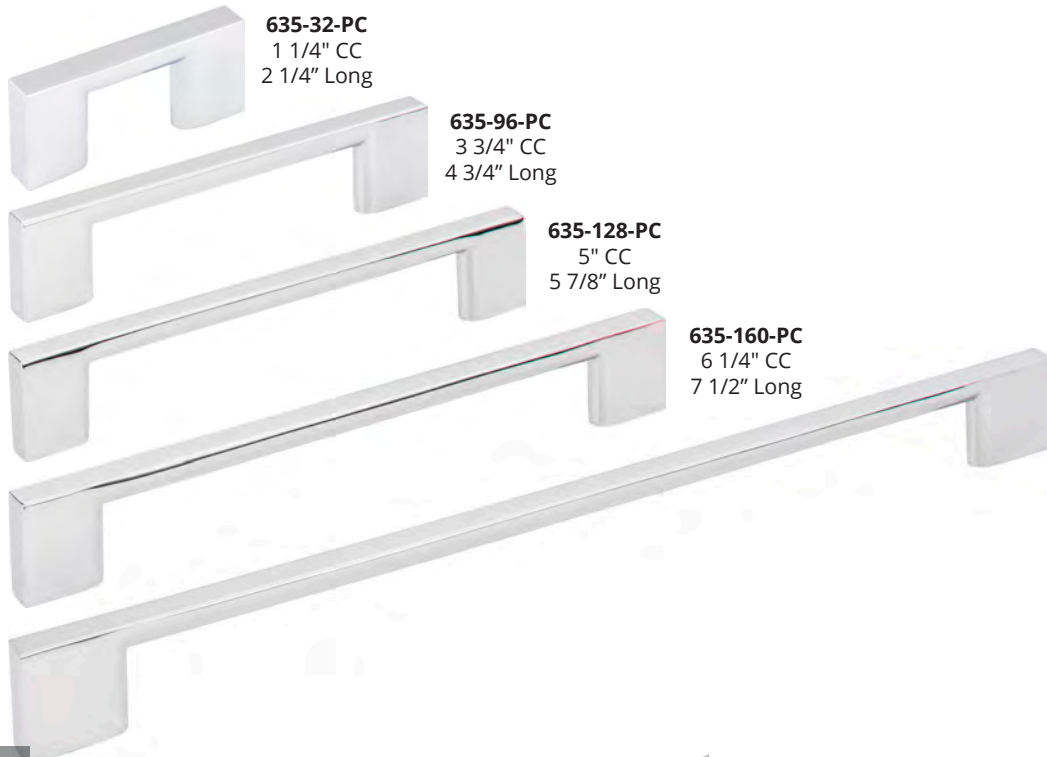
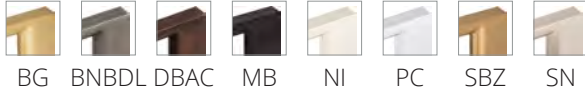

635-32-PC
1 1/4" CC
2 1/4" Long

635-96-PC
3 3/4" CC
4 3/4" Long

635-128-PC
5" CC
5 7/8" Long

635-160-PC
6 1/4" CC
7 1/2" Long

635-256-PC
10 1/16" CC
11 7/16" Long

Item
635-32
635-96
635-128
635-160
635-256

Symphony

AVAILABLE FINISHES



SN BNBDL DACM DBAC ABSB



1976-ABSB
Knob
2" Dia.



1977S-ABSB
Knob
1 3/8" Dia.

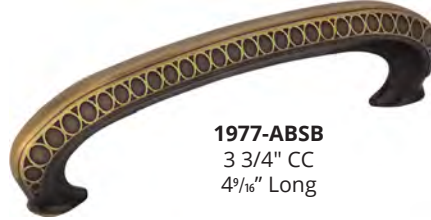

1977-ABSB
3 3/4" CC
4 9/16" Long

Item
1977S
1976
1977

Tahoe

AVAILABLE FINISHES



BLK DMAC SIM

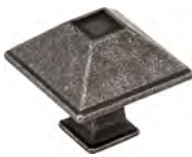

602S-SIM
Small knob
1 1/4" Dia.



602-SIM
Large knob
1 1/2" Dia.



602-96-SIM
3 3/4" CC
4 1/2" Long



602-128-SIM
5" CC
5 13/16" Long



602-12-SIM
12" CC
12 3/4" Long

Item
602S
602
602-96
602-128
602-12



775-128-SBZ
Carmen

Tiffany

AVAILABLE FINISHES



BG BNBDL DBAC NI PC SBZ SN



658-SBZ
Knob
1 1/4" Dia.

Item
658
658-96
658-128
658-160
658-192
658-224
658-12



658-96-SBZ
3 3/4" CC
4 1/2" Long



658-128-SBZ
5" CC
5 13/16" Long



658-160-SBZ
6 1/4" CC
7 1/16" Long



658-192-SBZ
7 9/16" CC
8 3/8" Long



658-224-SBZ
8 13/16" CC
9 7/8" Long

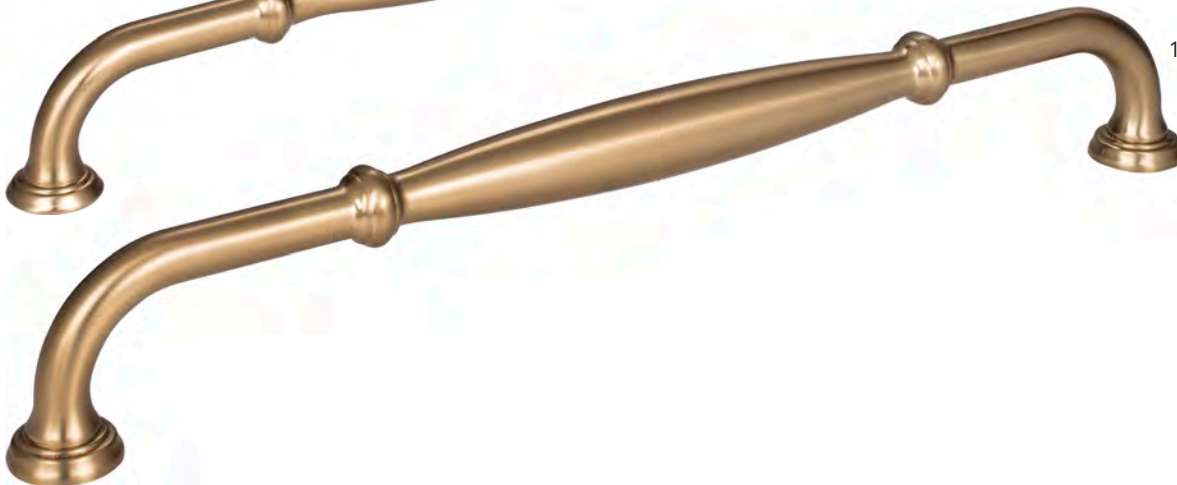

658-12-SBZ
12" CC appliance pull
13" Long

JEFFREY ALEXANDER

Tuscany

AVAILABLE FINISHES



ABSB DACM DBAC SIM



749-96B-SIM
3 3/4" CC
4 1/16" Long

749-SIM
Knob
2 5/16" Dia.

749-128B-SIM
5" CC
5 5/16" Long

749-128-SIM
5" CC bail pull
5 5/16" Long

749-160-SIM
6 1/4" CC bail pull
7 3/16" Long

749-224-SIM
8 13/16" CC bail pull
9 3/4" Long

Item
749
749-96B
749-128B
749-128
749-160
749-224

Wheeler – New!

AVAILABLE FINISHES



MB DBAC BNBDL SBZ BG SN PC



678-96-MB
96MM CC
5" Long



678-MB
Knob
1 1/4" Dia.

678-128-MB
128MM CC
6 1/4" Long

678-160-MB
160MM CC
7 1/2" Long

678-12-MB
18" CC appliance pull
20 1/4" Long

Item
678
678-96
678-128
678-160
678-18

JEFFREY ALEXANDER

Zane

AVAILABLE FINISHES

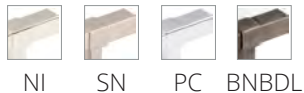

293-96-BNBDL
3 3/4" CC
5 1/16" Long



293T-BNBDL
Knob
2" Dia.

293-128-BNBDL
5" CC
6 5/16" Long

293-160-BNBDL
6 1/4" CC
7 9/16" Long

293-192-BNBDL
7 9/16" CC
8 13/16" Long

293-224-BNBDL
8 13/16" CC
10 1/16" Long

293-305-BNBDL
12" CC
13 3/4" Long

Item
293T
293-96
293-128
293-160
293-192
293-224
293-305

Zurich*

AVAILABLE FINISHES



***DISCONTINUED**
Limited Stock Available!



I300-ABSB
3" CC
3 7/16" Long



I350-ABSB
Knob
2" Dia.

I350-128-ABSB
5" CC bail pull
5 15/16" Long

I350-160-ABSB
6 1/4" CC
7 3/16" Long

Item
I350
I300
I350-128
I350-160

E L E M E N T S[®]
by Hardware Resources

Aiden

AVAILABLE FINISHES



993-BNBDL
Knob
1 5/8" Proj.



993-3-BNBDL
3" CC
4 1/16" Long



993-96-BNBDL
3 3/4" CC
4 13/16" Long



993-128-BNBDL
5 1/16" CC
6 1/8" Long

Item
993
993-3
993-96
993-128

Arcadia

AVAILABLE FINISHES

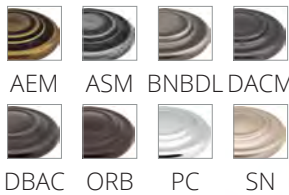

516-AEM
3" CC
5 1/2" Long



107-AEM
Knob
1 1/4" Dia.

Item
107
516

Asher

AVAILABLE FINISHES



193-3-BC
3" CC
3 1/4" Long



193-96-BC
3 3/4" CC
4" Long



193-4-BC
4" CC
4 1/4" Long



193-128-BC
5" CC
5 1/4" Long



193-160-BC
6 1/4" CC
6 9/16" Long

Item
193-3
193-96
193-4
193-128
193-160

Belfast

AVAILABLE FINISHES



	308-128-DN 5" CC 5 1/2" Long		406-128-DN 5" CC 6 1/2" Long	Item
	745-128-DN 5" CC 5 1/2" Long		776-128-DN 5" CC 5 1/2" Long	308-128
	976-128-DN 5" CC 6" Long			406-128
				745-128
				776-128
				976-128

Brenton

AVAILABLE FINISHES

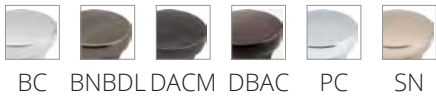

	239-96-BNBDL 3 3/4" CC 4 5/16" Long		239-BDBDL Knob 1" Dia.	Item
	239-128-BNBDL 5" CC 5 9/16" Long		239-160-BNBDL 6 1/4" CC 6 13/16" Long	239
	239-192-BNBDL 7 9/16" CC 8 1/16" Long			239-96
				239-128
				239-160
				239-192

Calloway

AVAILABLE FINISHES



	331-DBAC Small Knob 1 1/8" Dia.		331L-DBAC Large Knob 1 1/4" Dia.		351-DBAC Small Knob 1 1/8" Dia.		351L-DBAC Large Knob 1 1/4" Dia.	Item
	331-96-DBAC 3 3/4" CC 4 1/2" Long		351-96-DBAC 3 3/4" CC 4 7/16" Long		331-128-DBAC 5" CC 5 3/4" Long		351-128-DBAC 5" CC 5 11/16" Long	331
								351
								331L
								351L
								331-96
								351-96
								331-128
								351-128

Capri

AVAILABLE FINISHES



412461-SN
Knob
1 1/8" Dia.



530142-SN
Knob
1" Dia.



530143-DN
Knob
1 1/4" Dia.



3211-SN
3" CC
4 7/8" Long



4656-SN
3" CC
3 3/8" Long



411689-DN
3 3/4" CC
4 3/8" Long



4690-SN
3 3/4" CC
4 1/2" Long



530144-DN
3 3/4" CC
5 1/8" Long



417572-DN
5" CC
4 1/2" Long



Z205-BB
5" CC
5 3/4" Long



Z500-128-SN
5" CC
5 5/8" Long

Item
412461
530142
530143
3211
4656
411689
4690
530144
417572
Z205
Z500-128

NOTE: 412461, 530142, 3211, 4656, 4690 and Z500-128 are only available in SN Finish. 531043, 411689, 530144 and 417572 are only available in DN Finish. Z205 is only available in BB or BC Finishes.

Cosgrove

AVAILABLE FINISHES

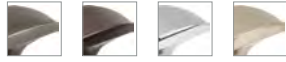

BNBDL DBAC PC SN

382-BNBDL
Knob
1 1/2" Dia.

382-96-BNBDL
3 3/4" CC
6 1/2" Long

382-128-BNBDL
5" CC
7 3/4" Long

382-160-BNBDL
6 1/4" CC
9" Long

Item
382
382-96
382-128
382-160

Cypress

AVAILABLE FINISHES



BNBDL DACM DBAC SN

Z118-DACM
Knob
1 1/4" Dia.

Z118-3-DACM
3" CC
3 3/8" Long

Z118-96-DACM
3 3/4" CC
4 1/8" Long

Item
Z118
Z118-3
Z118-96

Drake

AVAILABLE FINISHES



BNBDL DACM DBAC PC SN

423-DBAC
Faceted Knob
1 1/4" Dia.

424-DBAC
Flat Top Knob
1 3/16" Dia.

423-3-DBAC
3" CC
4" Long

423-96-DBAC
3 3/4" CC
4 3/4" Long

Item
423
424
423-3
423-96

Edgefield

AVAILABLE FINISHES

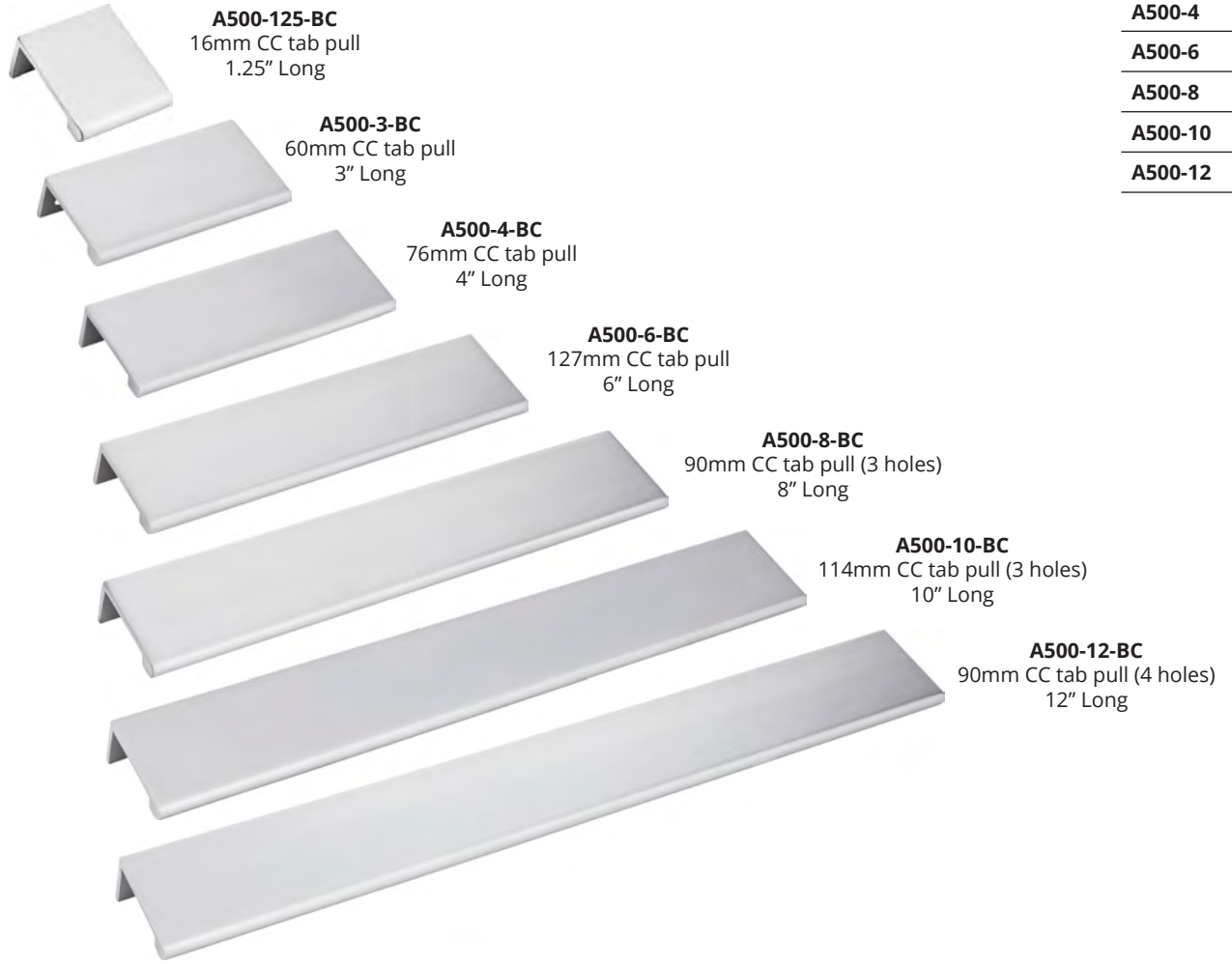
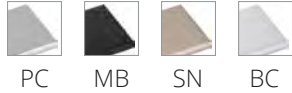

Item
A500-125
A500-3
A500-4
A500-6
A500-8
A500-10
A500-12

Florence

AVAILABLE FINISHES



2980-SBZ
Knob
1 1/4" Dia.



2981-SBZ
3" CC cup pull
3 11/16" Long

Item
2980
2981

Gatsby

AVAILABLE FINISHES



BNBDL DACM DBAC PC SN



3940-PC
Knob
1 1/4" Dia.



3950-PC
Knob
1 3/16" Dia.



3960-PC
Knob
1 1/4" Dia.



3970-PC
Knob
1 1/8" Dia.



3108-PC
3" CC
5 1/4" Long



3208-PC
3" CC
4 1/4" Long



3308-PC
3" CC
4 1/2" Long

Item
3940
3950
3960
3970
3108
3208
3308

Glendale

AVAILABLE FINISHES



ABM-DBNBDL DBAC DMAC SBZ

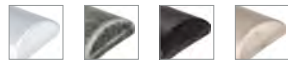

PC SIM MB SN



525-96-SIM
3 3/4" CC
5" Long

525-SIM
Knob
1" Dia.

Item
525
525-96

Gibson – New!

AVAILABLE FINISHES



MB BNBDL SBZ BG SN PC



105-96-SBZ
96MM CC
4 1/4" Long



105-128-SBZ
128MM CC
5 1/2" Long



105-160-SBZ
160MM CC
6 3/4" Long



105-192-SBZ
192MM CC
8" Long



105-SBZ
Knob
1 1/4" Dia.

Item
105
105-96
105-128
105-160
105-192

Hadly

AVAILABLE FINISHES

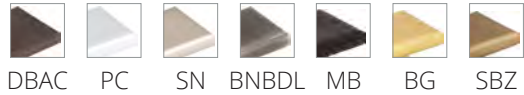

DBAC

PC

SN

BNBDL

MB

BG

SBZ



449-BNBDL
Knob
1" Dia.



449-3-BNBDL
3" CC
4" Long



449-96-BNBDL
96 mm CC
4 3/4" Long



449-128-BNBDL
5" CC
6 1/16" Long



449-160-BNBDL
6 1/4" CC
7 5/16" Long

Item
449
449-3
449-96
449-128
449-160

Hammond

AVAILABLE FINISHES



BNBDL

DBAC

PC

SN



525-SN
Knob
1" Dia.



937-3-SN
3" CC
4 7/8" Long



937-96-SN
3 3/4" CC
5 11/16" Long

Item
525
937-3
937-96

Kenner

AVAILABLE FINISHES

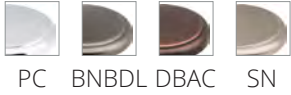

PC BNBDL DBAC SN



254-3-BNBDL
3" CC
5" Long

254-96-SN
3 3/4" CC
5 3/4" Long

3970-SN
Knob
1 1/8" Dia.

Item
3970
254-3
254-96

Knox

AVAILABLE FINISHES



MB SN PC

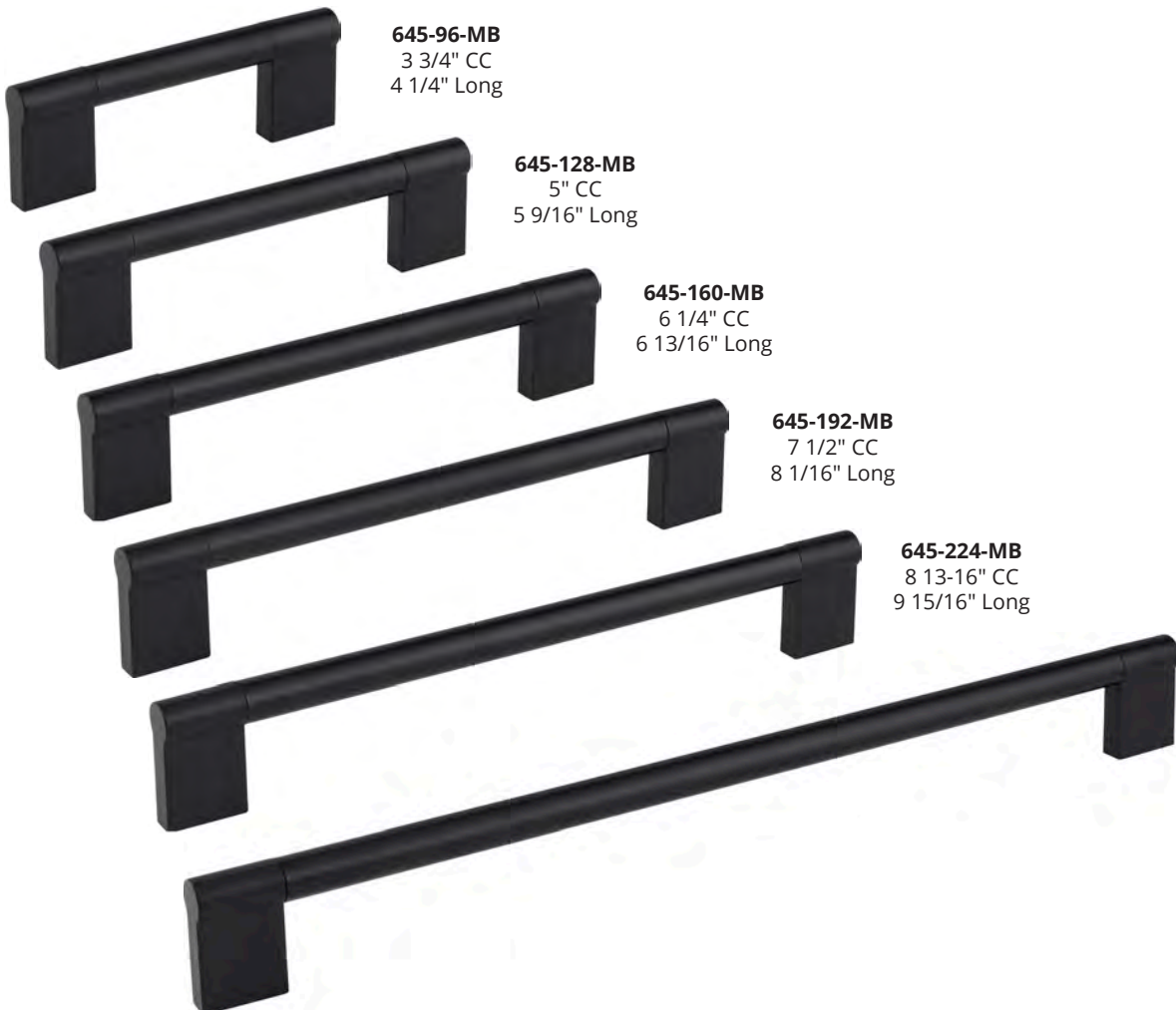

645-96-MB
3 3/4" CC
4 1/4" Long

645-128-MB
5" CC
5 9/16" Long

645-160-MB
6 1/4" CC
6 13/16" Long

645-192-MB
7 1/2" CC
8 1/16" Long

645-224-MB
8 13/16" CC
9 15/16" Long

645-320-MB
12 1/2" CC
13 1/16" Long

Item
645-96
645-128
645-160
645-192
645-224
645-320

Lindos

AVAILABLE FINISHES



BNBDL DBAC PC SN



Z115-BNBDL
Knob
1 1/4" Dia.



Z115L-BNBDL
Knob
1 3/8" Dia.



Z115-96-BNBDL
3 3/4" CC
4 3/8" Long



Z115-128-BNBDL
5" CC
5 9/16" Long

Item
Z115
Z115L
Z115-96
Z115-128

Madison

AVAILABLE FINISHES

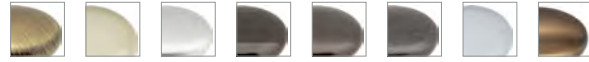

AB ALM BC BN BNBDL DACM WH SBZ



DBAC MB ORB PB SB SN PC



3910-AB
Knob
1 3/16" Dia.

Item
3910
Z259-3
Z259-12

NOTE: Z259-3 is not available in ALM or WH Finishes. Z259-12 is not available in ALM, BNBDL, MB, PB, SB or WH Finishes.



Z259-3-AB
3" CC
3 3/8" Long













Z259-12-AB
12" CC appliance pull
13" Long

Naples

AVAILABLE FINISHES



	40-PC Knob 40mm Dia.		
	136-SN 3" CC 156mm Long		
	156-MB 96mm CC 156mm Long		
	176-BG 128mm CC 176mm Long		
	206-SBZ 128mm CC 206mm Long		
	220-PC 160mm CC 220mm Long		
	272-SN 192mm CC 272mm Long		
	304-MB 224mm CC 304mm Long		
	336-BG 256mm CC 336mm Long		
	368-SBZ 288mm CC 368mm Long		
	399-PC 319mm CC 399mm Long		

Item
40
136
156
176
206
220
272
304
336
368
399
496
560
624
720
763

496
416mm CC
496mm Long
560
480mm CC
560mm Long
624
544mm CC
624mm Long
720
640mm CC
720mm Long
763
673mm CC
763mm Long

Naples

AVAILABLE FINISHES



SS



39-SS
Knob
39mm Dia.



154-SS
96mm CC
154mm Long



174-SS
128mm CC
174mm Long



204-SS
128mm CC
204mm Long



270-SS
192mm CC
270mm Long



302-SS
224mm CC
302mm Long



334-SS
256mm CC
334mm Long



366-SS
288mm CC
366mm Long

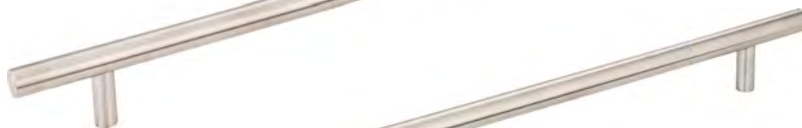

397-SS
319mm CC
397mm Long

Item
39
154
174
204
270
302
334
366
397
494
558
622
719
761

494-SS
416mm CC
494mm Long

558-SS
480mm CC
558mm Long

622-SS
544mm CC
622mm Long

719-SS
640mm CC
719mm Long

761-SS
673mm CC
761mm Long

Merryville

AVAILABLE FINISHES



BNBDL



DBAC



PC



SN



897-3-BNBDL
3" CC
5 1/8" Long



897-BNBDL
Knob
1 1/8" Dia.



897L-BNBDL
Knob
1 1/4" Dia.

Item	1+	25+	100+
897	\$1.44	\$1.31	\$1.19
897L	\$1.79	\$1.62	\$1.48
897-3	\$1.63	\$1.48	\$1.35

Park – New!

AVAILABLE FINISHES



DBAC BNBDL SN PC



183-PC
Knob
1 1/8" Proj.



183-3-PC
3" CC
3 3/4" Long



183-96-PC
96MM CC
4 1/2" Long

Item
183
183-3
183-96

Seaver – New!

AVAILABLE FINISHES



DBAC BNBDL SN PC



511-DBAC
Knob
1 1/4" Dia.



511-3-DBAC
3" CC
4 1/16" Long



511-96-DBAC
96MM CC
4 7/8" Long

Item
511
511-3
511-96

Sedona

AVAILABLE FINISHES



SN



26-SN
Knob
1" Dia.



400-SN
3" CC
4" Long



475-SN
3 3/4" CC
4 3/4" Long



600-SN
5" CC
6" Long

Item
26
400
475
600

Slade

AVAILABLE FINISHES



PC BNBDL SN DBAC AB DACM PB



984-3-DACM
3" CC
3 1/2" Long

984-96-DACM
3 3/4" CC
4 1/4" Long

3915-DACM
Knob
1" Dia.

984-128-DACM
5" CC
5 1/2" Long

984-160-DACM
6 1/4" CC
6 3/4" Long

984-192-DACM
7 9/16" CC
8" Long

NOTE: 984-3, 984-96, 984-128, 984-160 and 984-192 are not available in AB or PB Finishes.

Item
3915
984-3
984-96
984-128
984-160
984-192

Somerset

AVAILABLE FINISHES



BNBDL DBAC PC SN



8004-DBAC
3 3/4" CC
4 7/8" Long

81065-DBAC
5" CC
6" Long

80814-DBAC
3 3/4" CC
5" Long

80815-DBAC
5" CC
6 1/4" Long

Item
8004
81065
80814
80815

Stanton

AVAILABLE FINISHES

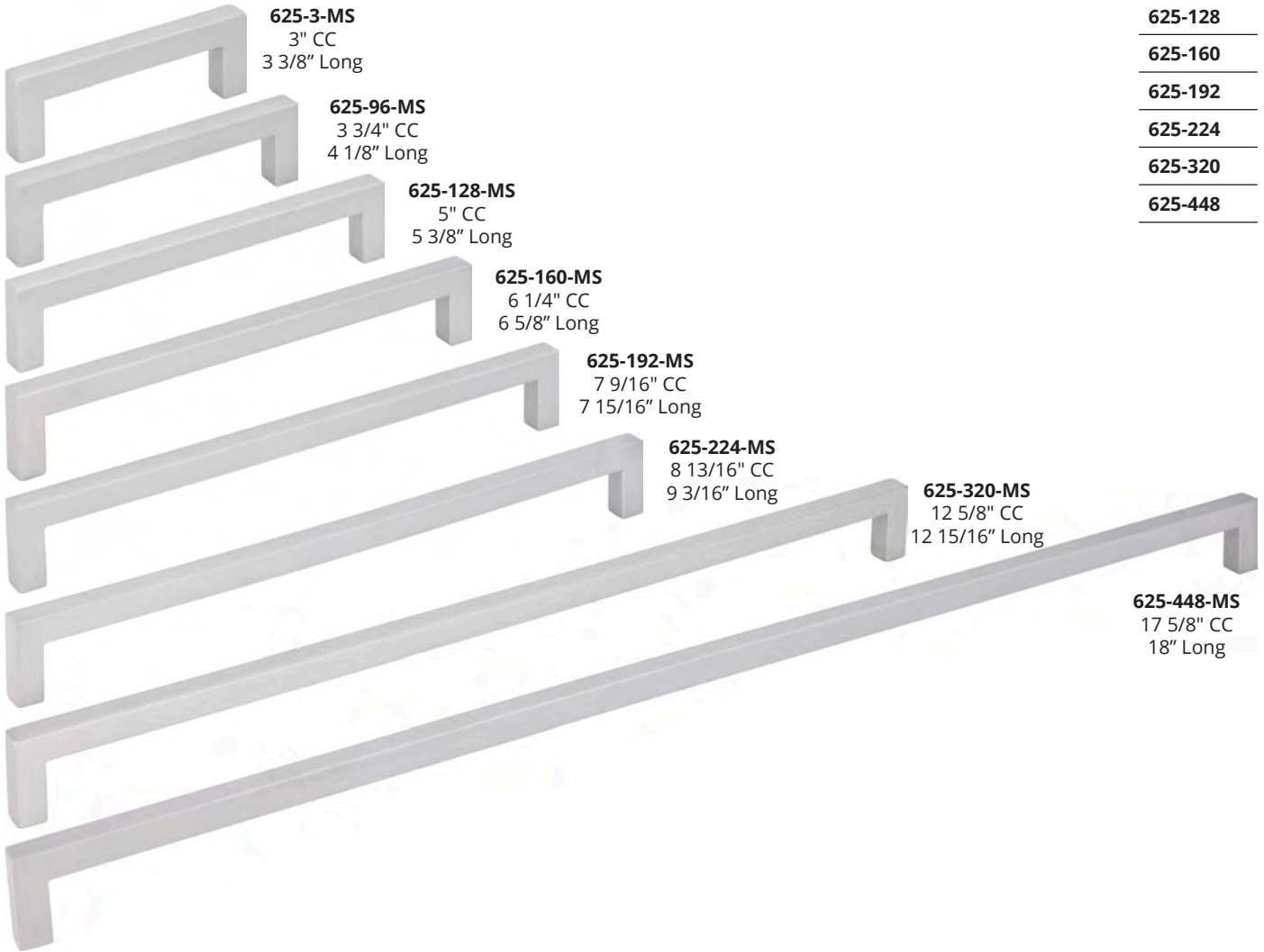

625-3-MS
3" CC
3 3/8" Long

625-96-MS
3 3/4" CC
4 1/8" Long

625-128-MS
5" CC
5 3/8" Long

625-160-MS
6 1/4" CC
6 5/8" Long

625-192-MS
7 9/16" CC
7 15/16" Long

625-224-MS
8 13/16" CC
9 3/16" Long

625-320-MS
12 5/8" CC
12 15/16" Long

625-448-MS
17 5/8" CC
18" Long

Item
625-3
625-96
625-128
625-160
625-192
625-224
625-320
625-448

Strickland

AVAILABLE FINISHES



771-3-SN
3" CC
4 1/2" Long

771-96-SN
3 3/4" CC
5 3/16" Long

771-128-SN
5" CC
6 5/16" Long

771-160-SN
6 1/4" CC
7 11/16" Long

Item
771-3
771-96
771-128
771-160

Syracuse

AVAILABLE FINISHES



BNBDL DBAC PC SN



575-96-BNBDL
3 3/4" CC
4 7/8" Long



575-BNBDL
Knob
1 3/16" Dia.

Item
575
575-96

Thatcher

AVAILABLE FINISHES



MB DBAC BNBDL SBZ BG SN PC



859T-SBZ
Knob
1 1/2" Dia.

Item
859T
859-3
859-96
859-128
859-160



859-3-SBZ
3" CC
5 1/4" Long



859-96-SBZ
3 3/4" CC
6" Long



859-128-SBZ
5" CC
7 1/4" Long



859-160-SBZ
6 1/4" CC
8 1/2" Long

859-128-SBZ
Thatcher



Torino

AVAILABLE FINISHES

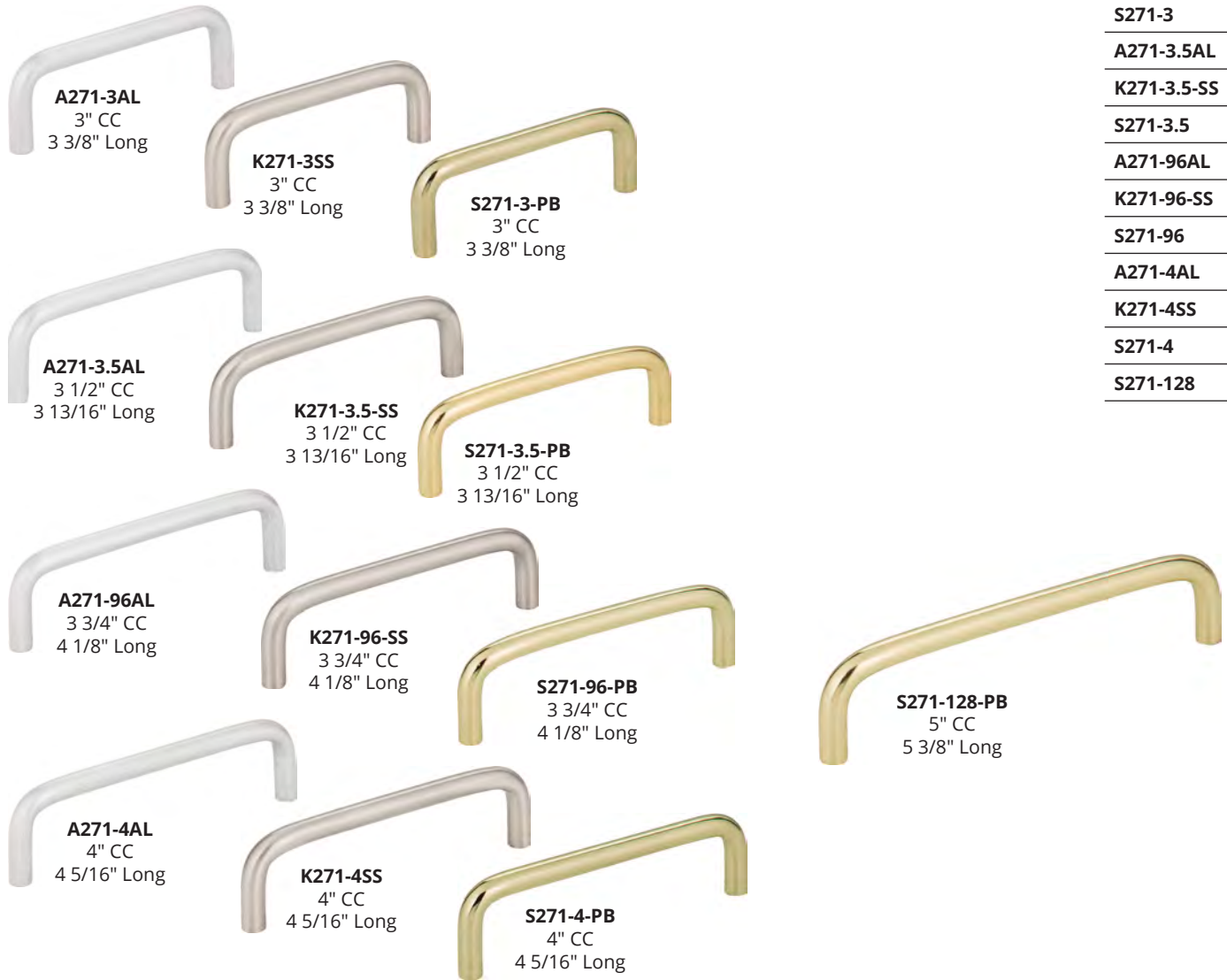

Item
A271-3AL
K271-3SS
S271-3
A271-3.5AL
K271-3.5-SS
S271-3.5
A271-96AL
K271-96-SS
S271-96
A271-4AL
K271-4SS
S271-4
S271-128

Vienna

AVAILABLE FINISHES

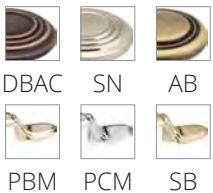

Item
110
202
110-3
P106

NOTE: AB Finish is only available for 202. PBM, PCM or SB Finishes are only available for P106.

Walker 1 – New!

AVAILABLE FINISHES



MB BNBDL SBZ BG SN PC



827-96-BG
96MM CC
4 1/8" Long



827-128-BG
128MM CC
5 3/8" Long



827-160-BG
160MM CC
6 11/16" Long



827-192-BG
192MM CC
7 15/16" Long



827-12-BG
12" CC
12 1/2" Long



827-BG
Square Knob
1 1/4" Long



827L-BG
Square Knob
1 5/8" Long

Item
827
827L
827-96
827-128
827-160
827-192
827-12

Walker 2 – New!

AVAILABLE FINISHES



MB BNBDL SBZ BG SN PC



727-96-PC
96MM CC
4" Long



727-128-PC
128MM CC
5 5/16" Long



727-160-PC
160MM CC
6 9/16" Long



727-192-PC
192MM CC
7 13/16" Long

Item
727-96
727-128
727-160
727-192

Watervale

AVAILABLE FINISHES

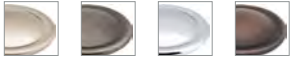

SN BNBDL PC DBAC



647-DBAC
Knob
1 1/8" Dia.



647-3-DBAC
3" CC
4 5/8" Long



647-96-DBAC
3 3/4" CC
5 3/8" Long

Item

647

647-3

647-96

Westbury

AVAILABLE FINISHES



BNBDL DBAC PC SN



3898-PC
Knob
1 1/4" Dia.



3899-PC
3" CC
5 1/8" Long

Item

3898

3899

Zachary

AVAILABLE FINISHES

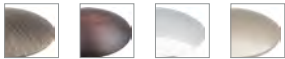

BNBDL DBAC PC SN



988-3-SN
3" CC
3 3/4" Long



988-SN
Knob
1 1/6" Dia.



988-96-SN
3 3/4" CC
4 1/2" Long



988-128-SN
5" CC
5 3/4" Long



988-160-SN
6 1/4" CC
7 1/16" Long

Item

988

988-3

988-96

988-128

988-160



Mulholland - page 28
front cover | Everett - page 20



330-897-0017 | fax orders 330-897-0022
1465 Township Road 178 • Baltic, Ohio 43804

